

# RADIO CRAFT

*In this issue —*

New Direction Finder  
Radio Test Equipment  
Shaping Waveforms



**SUPERSONIC "RADAR"  
FOR SMALL CRAFT  
SEE PAGE 732**

**RADIO-ELECTRONICS IN ALL ITS PHASES**

**AUG**

194

**25**

CANADA

# new *Electro-Voice* Comet

## COMBINED CRYSTAL MICROPHONE AND STAND

**Beautiful Symmetry, Fine  
Performance and Utility  
... at Low Cost!**

Now *Electro-Voice* brings you the benefit of advanced design and engineering in a new, high quality, low-priced crystal microphone.

*There is nothing like the COMET.* Expert air-flow styling combines beauty with utility. Microphone head and stand are functionally integrated into one unit, and perfectly balanced. Molded in one piece of high impact, butyrate plastic in deep lustrous gray. Light weight—yet virtually non-breakable under normal use. Convenient and easy to use as a hand-held microphone—or stands firmly on base for desk or table use.

*Electro-Voice* internal construction, together with high capacity, moisture sealed crystal, provides *smooth*, wide-range response and *very high output level* . . . assures excellent reproduction of voice and music.

The COMET may be used for individual or group pick-up. It is particularly suitable for home recording, economical public address, paging, and amateur radio communications.

Model 902. Comet. List Price . . . . . **\$13.25**

### SPECIFICATIONS

**Output Level Rating:** 48 db below 1 volt/dyne/cm<sup>2</sup>, open circuit. Voltage developed by normal speech (10 dynes/cm<sup>2</sup>): .0394 volt. **Frequency Response:** 70-7000 c.p.s., substantially flat. **Impedance:** Hi-Z. Can be used with any standard amplifier employing high impedance input. **Cable:** Equipped with 7½ feet of well-shielded, synthetic rubber jacketed cable. **Net Weight:** 15 ounces.

*Available now. Order today, or write  
for further details.*

### ELECTRO-VOICE, INC.

1239 South Bend Ave., South Bend 24, Indiana  
Export Division: 13 East 40th Street, New York 16, N.Y., U.S.A.  
Cables: Arlab

(Licensed under Brush patents)



**COMET**  
Model 902  
LIST PRICE  
**\$13.25**

NO FINER CHOICE THAN

***Electro-Voice***  
MICROPHONES



# I Will Show You How to Learn RADIO by Practicing in Spare Time

I Send You 6 Big Kits of Radio Parts

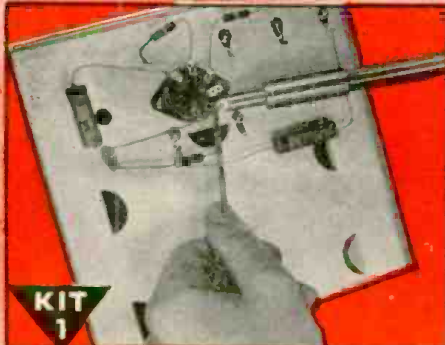

**KIT 1**  
I send you Soldering Equipment and Radio parts; show you how to do Radio soldering; how to mount and connect Radio parts; give you practical experience.



**KIT 2**  
Early in my course I show you how to build this N.R.I. Tester with parts I send. It soon helps you fix neighborhood Radios and earn EXTRA money in spare time.

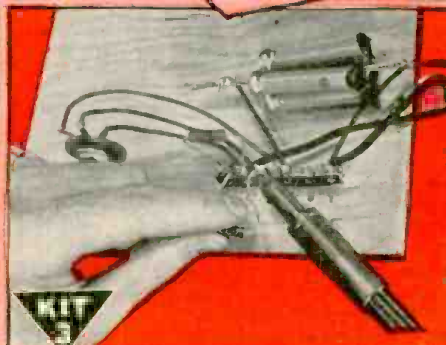

**KIT 3**  
You get parts to build Radio Circuits; then test them; see how they work—learn how to design special circuits; how to locate and repair circuit defects.

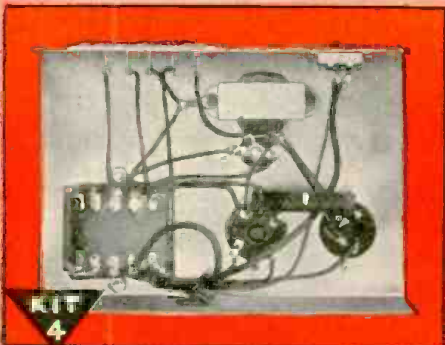

**KIT 4**  
You get parts to build this Vacuum Tube Power Pack; make changes which give you experience with packs of many kinds; learn to correct power pack troubles.

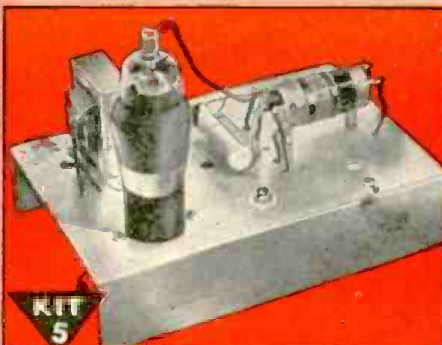

**KIT 5**  
Building this A. M. Signal Generator gives you more valuable experience. It provides amplitude-modulated signals for many tests and experiments.



**KIT 6**  
You build this Superheterodyne Receiver which brings in local and distant stations—and gives you more experience to help you win success in Radio.

## I Will Train You at Home - SAMPLE LESSON FREE

Do you want a good-pay job in Radio—or your own money-making Radio Shop? Mail Coupon for a FREE Sample Lesson and my FREE 64-page book, "Win Rich Rewards in Radio." See how N.R.I. gives you practical Radio experience at home—building, testing, repairing Radios with parts I send!

Many Beginners Soon Make EXTRA Money In Spare Time While Learning

The day you enroll I start sending EXTRA MONEY JOB SHEETS. You LEARN Radio principles from my easy-to-grasp, illustrated lessons—PRACTICE what you learn with parts I send—USE your knowledge to make EXTRA money fixing neighbors' Radios in spare time while still learning! From

**My Radio Course Includes TELEVISION • ELECTRONICS FREQUENCY MODULATION**

here it's a short step to your own full-time Radio Shop or a good Radio job!

### Future for Trained Men Is Bright in Radio, Television, Electronics

It's probably easier to get started in Radio now than ever before because the Radio Repair business is booming. Trained Radio Technicians also find profitable opportunities in Police, Aviation, Marine Radio, Broadcasting, Radio Manufacturing, Public Address work. Think of even greater opportunities as Television and Electronics be-

come available to the public! Send for free books now!

### Find Out What N.R.I. Can Do for You

Mail Coupon for Sample Lesson and my 64-page book. Read the details about my Course. Read letters from men I trained, telling what they are doing, earning. See how quickly, easily you can get started. No obligation! Just MAIL COUPON NOW in an envelope or paste it on a penny postal. J. E. SMITH, President, Dept. 6HX National Radio Institute, Pioneer Home Study Radio School, Washington 9, D. C.

APPROVED FOR TRAINING UNDER GI BILL

## Good for Both - FREE

Mr. J. E. SMITH, President, Dept. 6HX  
National Radio Institute, Washington 9, D. C.  
Mail me FREE, without obligation, Sample Lesson and 64-page book about how to win success in Radio and Television—Electronics. (No salesman will call. Please write plainly.)

Age .....

Name .....

Address .....

City ..... State .....

(Please include Post Office zone number)



# SYLVANIA NEWS

## RADIO SERVICE EDITION

AUG. Prepared by SYLVANIA ELECTRIC PRODUCTS INC., Emporium, Pa. 1946

### "CARRY THE TUBES THAT BUILD GOODWILL" IS THEME OF SYLVANIA TUBE QUALITY STORY

**SYLVANIA  
SERVICEMAN  
SERVICE**

by  
**FRANK FAX**



Carrying the *complete* line of Sylvania receiving tubes is one of the best ways to build goodwill for your business.

You can be sure of this because of the public's recognition of Sylvania's high quality. Extensive national advertising has helped promote this recognition — and acceptance. **QUALITY CONTROL** backs up this story of Sylvania quality.

Before Sylvania tubes can be shipped to your distributor, they must first pass a series of stiff tests conducted by an efficient Quality Control Department. Only those tubes that are proved to be electrically and mechanically perfect ever reach you.

Sylvania makes its own tube parts — over forty-five million a month. Even the fine tungsten wire filaments for Sylvania tubes are *Sylvania-made* to safeguard the quality of this vital tube element.

As a result, Sylvania can keep a close check on every tube — from raw materials straight through to the finished product.

Remember the story of Sylvania quality! It is one reason why carrying Sylvania tubes means you will receive a lot extra in the way of *goodwill*.

**SEE YOUR SYLVANIA DISTRIBUTOR**

*For full information on the complete line of Sylvania receiving tubes — and the long list of valuable business and technical aids for you — call on your local distributor.*

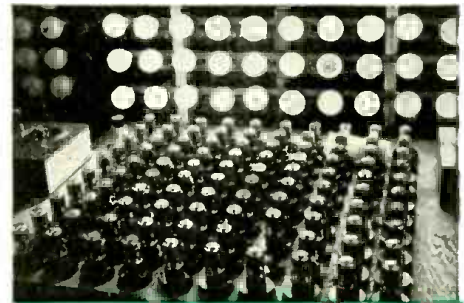

Completed tubes are being "aged" to stabilize characteristics. Then they get continuity, short and noise tests.



Tubes are here being given the Life Test — as another check on design, quality and dependable service.



Part of the Emporium, Pa., Tube Plant, where pleasant surroundings help keep employees tuned to quality workmanship.

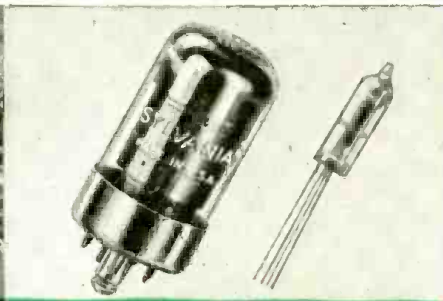

Quality products—the Sylvania Lock-In tube, and the tiny T-3 tube of proximity fuze fame.



This operation gives a percentage of all previously tested tubes a thorough going-over—just as a "double-check."

# SYLVANIA ELECTRIC

Emporium, Pa.

MAKERS OF RADIO TUBES; CATHODE RAY TUBES; ELECTRONIC DEVICES; FLUORESCENT LAMPS, FIXTURES, WIRING DEVICES; ELECTRIC LIGHT BULBS

**YOU name the brand—**  
(original equipment or replacement)

# PHOTOFACT FOLDERS

give you the exact  
part numbers

The manufacturers behind these and many other famous radio trademarks, including many radio set manufacturers, say that Howard W. Sams PhotoFact\* Folders offer you the most revolutionary service data ever devised. They claim—and rightly—that they can save up to 50 percent of any radio service engineer's time.

No wonder! PhotoFact Folders tell you—by data and pictures—everything you want to know about servicing every post-war radio made. Every part is listed and numbered. Every servicing shortcut and installation fact is fully set down! This at a time when receivers are more complicated than ever!

You get a set of from 30 to 50 PhotoFact Folders at a time. Each set comes to you in a handy envelope at a cost of only \$1.50 for each group. They cover all new radios, phonographs, intercommunication systems and power amplifiers as they reach the market.

Demand for the Howard W. Sams PhotoFact Folder Service is phenomenal. Paper shortages may make it impossible to send you the first sets immediately. But reprints are now being made—and you will get additional sets as fast as they are issued. Ask your distributor for full details and specimen folders. Have him put your name on his reservation list!

**HOWARD W. SAMS & CO., INC.**  
2924 East Washington Street, Indianapolis 6, Indiana

*\*Trademark Registered*

## WHAT THE PHOTOFACT SERVICE IS:

It's a new and radically different method of giving you the complete service story on every receiver manufactured since January 1, 1946.

All information is compiled by experts—from actual examination of models themselves, not from ordinary service data. No brand of product is recommended above another—all original

equipment part numbers are listed as well as competitive component part numbers. Each Folder gives you from 2 to 12 clear photos of the chassis... a keyed reference alignment procedure... complete voltage and resistance analyses... complete stage gain measurement data... plus a schematic diagram.

**PUBLICATION DATE—SET NO. 2**  
**JULY 25th—ORDER TODAY**

**HOWARD W. SAMS & CO., INC. RADIO PHOTOFACT SERVICE**

# GOODBYE TO MAN-MADE RADIO NOISES!

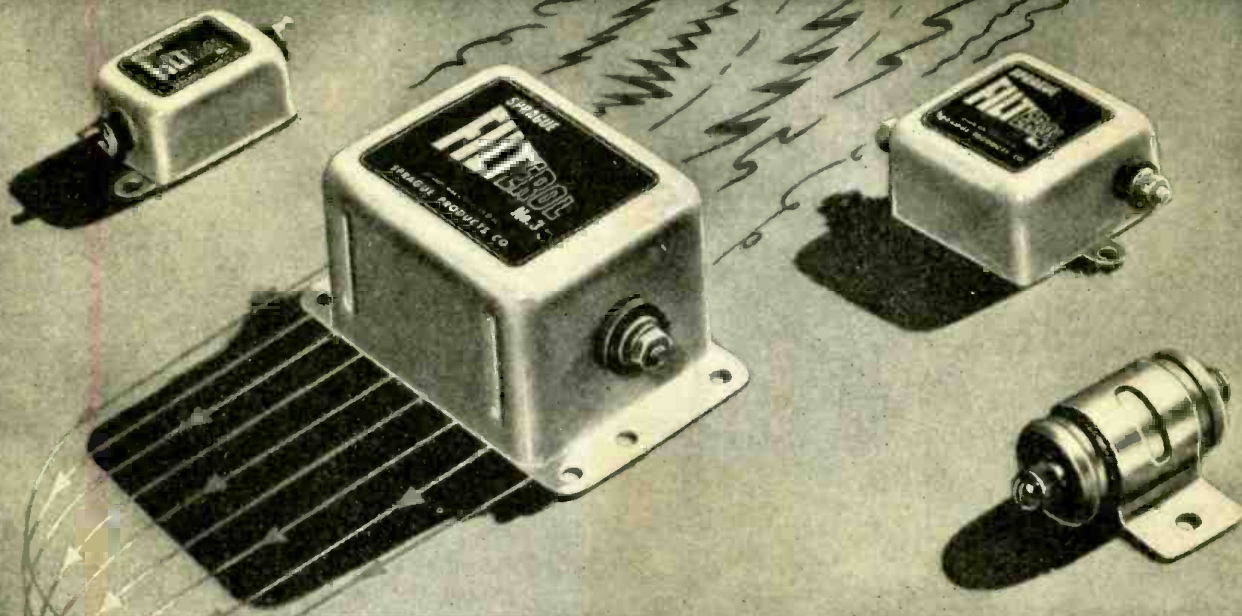

## SPRAGUE FILTEROL

The famous wartime 3-terminal network noise filter development



### GET THIS NEW CATALOG I

Contains complete details, dimensions, data, etc., on Sprague Capacitors and \*Koolohm Resistors for every radio service, amateur and experimental need.

\*Trademarks Reg. U. S. Pat. Off.

Don't waste time trying to stop man-made radio noises with plug-in filters or by other old-style, inefficient methods. Instead, install Sprague FILTEROLS directly across the line or terminals of the offending device. Do the job in the same efficient manner that made these amazing Sprague 3-terminal networks the outstanding filters for all types of war equipment!

#### FILTEROL TYPES 1, 2 AND 3

These light-weight, highly compact filters are rated 1, 10 and 35 amperes respectively at 115 volts A.C. They provide effective filtering throughout the entire broadcast band. Their basic circuit is a Sprague 3-terminal network of which the can is one terminal. Selection is based on current rating, the filter used having a rating *higher* than the continuous operating current of the device being filtered. Unexcelled for all small motors, flashing signs and similar radio noise producers.

#### FILTEROL TYPE 4

This unit incorporates a famous Sprague \*HYPASS Capacitor and provides exceptionally high attenuation at frequencies above 5 mc. and is effective up to 150 mc. or more. It is designed for filtering small devices having continuous current ratings up to 20 amperes.

Be the acknowledged interference expert in your locality! Get next to FILTEROLS today!

### SPRAGUE PRODUCTS COMPANY

NORTH ADAMS, MASSACHUSETTS

JOBGING DISTRIBUTING ORGANIZATION FOR PRODUCTS OF THE SPRAGUE ELECTRIC CO.

RADIO-CRAFT for AUGUST, 1946

# LET ME TRAIN YOU

for RADIO ELECTRONICS & TELEVISION

I'll Supply a **FULL RADIO SET**

for SIMPLIFIED INSTRUCTION — PRACTICE & TESTING

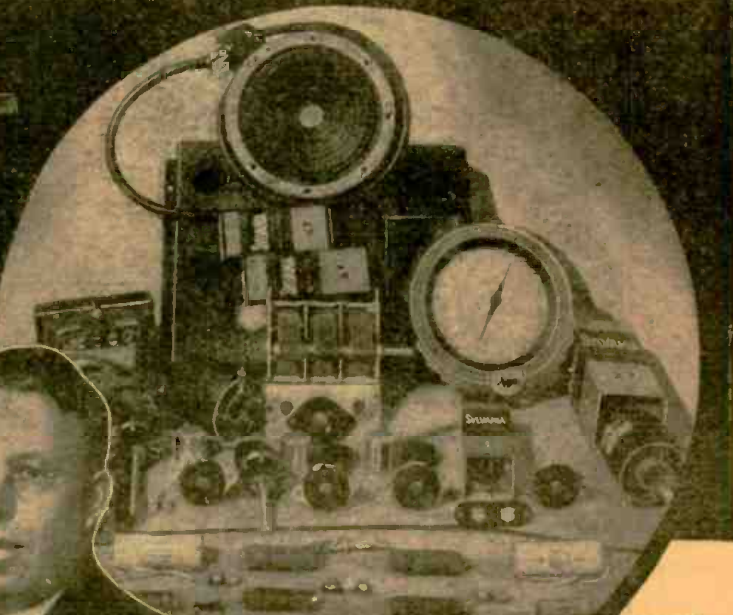

**Beginners Learn FAST**  
**START NOW!** Big Developments  
 Ahead in F. M., Radar, Television

**MAKE GOOD MONEY IN**  
**a Business of Your Own**  
**...or a Good Radio Job.**



MinC training through hand practice with a FULL RADIO SET . . . that's the interesting way I'll teach you Radio. And it's the latest, most practical method of all to fix in your head permanently the essential money-making Radio knowledge. The offer I make you here is the opportunity of a lifetime. I'll prepare you easily and quickly for a wonderful future in the swiftly expanding field of Radio-Electronics INCLUDING Radio, Television, Frequency Modulation and Industrial Electronics. Be wise! NOW'S the time to start. Opportunities ahead are tremendous! No previous experience is necessary. The Sprayberry Course starts right at the beginning of Radio. You can't get lost. It gets the various subjects across in such a clear, simple way that you understand and remember. And, you can master my entire course in your spare time . . . right at home.

**You Do Practical Experiments**

There's only one right way to learn Radio Electronics. You must get it through simplified lesson study combined with actual "shop" practice under the personal guidance of a qualified Radio Teacher. It's exactly this way that Sprayberry trains you . . . supplying real Radio parts for learn-by-doing experience right at home. Thus, you learn faster, your understanding is clear-cut.

**I'll Show You a New, Fast Way to Test Radio Sets Without Mfg. Equipment**

The very same Radio Parts I supply with your Course for gaining pre-experience in Radio Repair work may be adapted through an exclusive Sprayberry wiring procedure to serve for complete, fast, accurate Radio Receiver trouble-

shooting. Thus, under Sprayberry methods, you do not have one cent of outlay for manufactured Test Equipment.

**Succeed As a Radio-Electronician**

My training will give you the broad, fundamental principles so necessary as a background, no matter which branch of Radio you wish to specialize in. I make it easy for you to learn Radio Set Repair and Installation Work. I teach you how to install and repair Electronic Equipment. In fact, you'll be a fully qualified RADIO-ELECTRONICIAN, equipped with the skill and knowledge to perform efficiently and to make a wonderful success of yourself.

**Read What Graduate Says**  
**"One Job Nets About \$26.00"**

"Since last week I fixed 7 radios, all good-paying jobs, and right now I am working on an amplifier system. This job alone will net me about \$26.00. As long as my work keeps coming in this way, I have only one word to say and that is, 'Thanks' to my Sprayberry training, and I am not afraid to boast about it."—ADRIEN BENJAMIN, North Grosvenordale, Conn.

**DON'T PUT IT OFF!**

Get the facts about my training—now! Take the first important step toward the money-making future of your dreams. All features are fully explained in my big, illustrated FREE Catalog which comes to you along with another valuable FREE book you'll be glad to own.

## FREE BOOKS

"How To Read Radio Diagrams and Symbols"

Here's a valuable and wonderfully complete new book which explains in simple, non-technical English how to read and understand any Radio Set Diagram. Provides the quick key to analyzing any Radio circuit. Includes translations of all Radio symbols. This instructive volume is yours for the asking—without obligation. Send for it AT ONCE, and along with it I will send you another big free book, describing in complete, interesting detail my Radio-Electronic training.



**RUSH**  
**COUPON**  
 for **BOTH**

**SPRAYBERRY ACADEMY OF RADIO**  
 F. L. Sprayberry, President  
 Room 2086, Pueblo, Colorado

Please rush my FREE copies of "How to MAKE MONEY in RADIO ELECTRONICS and TELEVISION," and "How to READ RADIO DIAGRAMS and SYMBOLS."

Name ..... Ago.....

Address .....

City ..... State.....  
 (Mail in envelope or paste on penny postcard)

**MAIL COUPON AT ONCE!**

RADIO-CRAFT for AUGUST, 1946

# RADIO CRAFT

AND POPULAR ELECTRONICS  
 Incorporating  
 SHORT WAVE CRAFT TELEVISION NEWS  
 RADIO & TELEVISION



HUGO GERNSBACK, *Editor-in-Chief*  
 FRED SHUNAMAN, *Managing Editor*  
 MAJ. M. H. GERNSBACK, *Cons'l'g Ed.*  
 R. F. SCOTT, W2PWG, *Technical Editor*  
 I. QUEEN, W2OUX, *Editorial Associate*  
 ELMER FULLER, *Shortwave Editor*  
 A. PASCALE, *Production Manager*  
 G. ALIQUO, *Circulation Manager*  
 JOHN J. LAMSON, *Advertising Director*  
 ALFRED STERN, *Promotion Manager*

## IN AN EARLY ISSUE

Rebuilding a Televiser  
 5-Tube Superheterodyne  
 Instability in Apparatus  
 Design of Audio Mixers

Published by Radecraft Publications, Inc.  
 Publication Office: 29 Worthington Street,  
 Springfield 3, Mass.  
 Editorial and Advertising Offices: 25 West  
 Broadway, Tel. RE 2-9690, New York 7, N. Y.  
 Chicago Advertising Office: Radio-Craft, 308  
 W. Washington Street, Suite 1413, Chicago 6,  
 Ill. Tel. Randolph 7363.  
 Cleveland Advertising Office: 405 Erie Bldg.,  
 Cleveland, Ohio. Burdette Phillips, Manager.  
 Tel. Main 9645.  
 Detroit Advertising Office: 307-8 Boulevard  
 Bldg., Detroit, Mich. C. Frank Holstein, Man-  
 ager.  
 Los Angeles Advertising Office: 606 South  
 Hill Street, Los Angeles 14, Calif. Ralph W.  
 Harker, Manager. Tel. Tucker 1793.  
 San Francisco Advertising Office: 582 Market  
 St., San Francisco 4, Calif. Ralph W. Harker,  
 Manager. Tel. Garfield 2481.  
 RADIO-CRAFT is published monthly on the  
 25th of the month preceding that of date.  
 Subscription rates: United States and pos-  
 sessions, Mexico, Central and South American  
 countries, \$2.50 a year, \$4.00 for two years,  
 \$6.00 for three years. Canada, \$3.00 a year,  
 \$5.00 for two years, \$7.50 for three years.  
 All other foreign countries, \$3.25 a year,  
 \$5.50 for two years, \$8.25 for three years.  
 Special rates for members of the Armed  
 Forces in U. S., or those addressed by A.P.O.  
 or F.P.O. mail, \$2.00. Entered at the post  
 office at Springfield as second-class matter  
 under the Act of March 3, 1879. All com-  
 munications about subscriptions should be  
 addressed to: Circulation Manager, Radio-  
 Craft, 25 West Broadway, New York 7, N. Y.

Notice of CHANGE of ADDRESS should  
 reach us at least one month in advance. When  
 ordering a change, please furnish an address  
 stencil impression from a recent wrapper if  
 you can. Address changes cannot be made  
 without the old address as well as the new.

### Foreign Agents

London—Atlas Publishing and Distributing  
 Co., Ltd., 18 Bride Lane, Fleet St., London,  
 E.C. 4.  
 Melbourne—McGill's Agency, 179 Elizabeth  
 St., Australia.

Text and illustrations of this magazine are  
 copyright and must not be reproduced without  
 permission of the copyright owners.  
 Copyright, 1946, Radecraft Publications, Inc.

**RAD-CRAFT PUBLICATIONS, INC.:**  
 Hugo Gernsback, *President*  
 Maj. M. Harvey Gernsback, *Vice Pres.*  
 G. Aliquo, *Secretary*

## Contents August, 1946 Volume XVII No. 11

Editorial: Why No "Postwar" Radios? .....	by Hugo Gernsback	745
Radio-Electronics Monthly Review .....		746
Army Signal Association .....	by Maj. Gen. H. C. Ingles	748
Transatlantic News .....	by Ralph Hallows	765
Radio Thirty-Five Years Ago .....		787

### ELECTRONICS

Better Direction Finder .....	by Edward D. Padgett	750
The "Sonicator" (Cover Feature) .....		752
Television for Today, Part III—More on Camera Tubes and Scanning Methods .....	by Milton S. Kiver	759
Wave Shaping Circuits .....	by Seymour Fishman	761

### SERVICING

Photofacts for Servicemen .....		758
Radio Data Sheet No. 338 (General Electric Model 250) .....		762
Tone Control Circuits .....	by Leon A. Wortman	763
Check List for Repairmen .....	by N. M. Smith	764
Case of the Empty Socket .....	by N. H. Silverman	795
Servicemen Are Honest .....		774

### TEST INSTRUMENTS

Widerange Pocket Tester .....	by Harold Pallatz	749
Tube Checker Modernizer .....	by Harold A. Foster	753
Tracer Plus Power Supply .....	by W. H. Watkins	756

### CONSTRUCTION

Transmitter Output Stage .....	by Harry D. Hooton, W3KPX	755
A Simple Transitor .....	by I. Queen, W2OUX	794

### DEPARTMENTS

World-Wide Station List .....	by Elmer R. Fuller	766
Why Not? .....		767
New Radio-Electronic Devices .....		768
Technotes .....		770
Radio-Electronic Circuits .....		778
Try This One .....		780
The Question Box .....		782
New Radio-Electronic Patents .....	by I. Queen	784
Available Radio-Electronic Literature .....		786
Communications .....		796
Book Reviews .....		807

Biographical Portrait Drawings by Constance Joan Naar



### ON THE COVER

The apparatus shown on our cover this month is a sonic "radar" equipment, which sends out signals at audio frequencies, receives the echoes as they return and measures the elapsed time in terms of distance in feet on a calibrated dial, indicating direction and distance of obstacles in the course.



**MARKET FOR 100 MILLION RADIOS REVEALED BY SYLVANIA SURVEY**  
 OVER FIVE- OR SIX-YEAR PERIOD, RESULTS SHOW Instruments Found Popular  
 Radio-Phone

**BENDIX REVEALS PLANS TO DEVELOP SALES OF PERSONAL PLANE RADIO**

**RADIO AND TELEVISION "BOOM" IS ENVISIONED BY SENATE COMMITTEE**  
 KEY TO EXPANSION  
 sets Optimism in Post-  
 vision and FM — In-  
 electronics and Radar  
 ing Fields.

**Reconversion and Jobs In the Radio Industry**

**RADAR TO GUIDE FUTURE TRAVEL**  
 CHARGE  
 ing Has  
 nce  
 cal

**RADIO INDUSTRY FACES BRIGHT FUTURE**

**FOR REAL  
 JOB SECURITY  
 NOW AND  
 IN THE FUTURE..**

*Learn* **RADIO**  
**ELECTRONICS**  
 AT HOME OR IN OUR CHICAGO LABORATORIES  
**DeFOREST'S MODERN A-B-C WAY!**



Are you looking for *job security and good pay*? Take a look at today's headlines! You'll see that the billion dollar Radio-Electronic field offers some of America's most promising *present and future opportunities*. Think of the opportunities ahead in F. M. Radio, Broadcast Radio, Radio Sales and Service, Two-Way Train Radio, Motion Picture Sound, Aviation Radio, a Radio Business of Your Own, Electronics, etc. Here's a field that's wide awake—that's full of action, opportunities for advancement—fascinating work.

home training advantages of actual MOVIES and "Synco-Graphic" Lesson Texts, prepared under the supervision of Dr. Lee DeForest, the "Father of Radio," actually help make learning *faster-easier . . .* and much more enjoyable, more interesting. The 133 fascinating experiments, which you make with the 8 Big Kits of Radio Parts and Assemblies you use, give you practical "Shop Training" right in your own home.

If you are even slightly mechanically minded . . . if you can follow *clear, easy-to-understand instructions*—you can learn all about Radio-Electronics and its many applications in Industry, Radar, FM, Fac-Simile, etc. DeForest's Modern A-B-C Method simplifies learning! The *exclusive DeForest's*

**YOU GET EMPLOYMENT SERVICE, TOO**

When you complete DeForest's Training you get the help of DeForest's *Effective Employment Service* to help you get started in this billion-dollar ELECTRONIC opportunity industry . . . to help line you up for a good job. *Mail coupon NOW* for complete information—get the big "Victory for You!" book and Equipment folder—see how easy it is to get started at once. No obligation. Note: *Complete Residential Training is available in our Modern Chicago Laboratories shown at left . . . ask about it: Mail coupon today, sure!*

**ONLY DeFOREST'S PROVIDES ALL THREE HOME TRAINING AIDS**

- A** A 16 MM. MOVIE PROJECTOR AND LEARN-BY-SEEING FILMS
- B** ACTUAL RADIO PARTS TO WORK OUT EXPERIMENTS
- C** "SYNCO-GRAPHIC" LESSON TEXTS PREPARED BY DR. LEE DeFOREST

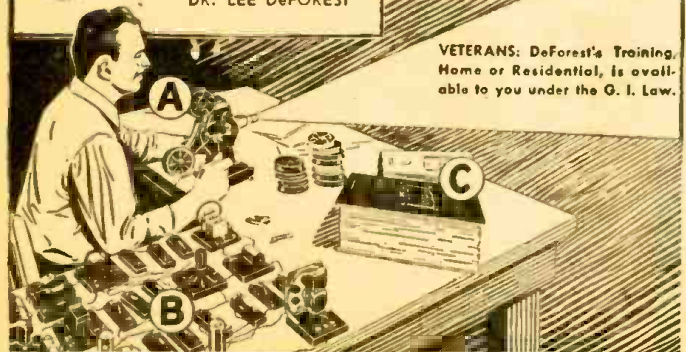

VETERANS: DeForest's Training, Home or Residential, is available to you under the G. I. Law.

**DeFOREST'S TRAINING INCLUDES INSTRUCTION IN MOTION PICTURE SOUND EQUIPMENT, FM RADIO AND TELEVISION . . .**

E. B. DeVry, President  
**DeFOREST'S TRAINING, INC.**  
 2535-41 North Ashland Ave., Dept. RC-C8  
 Chicago 14, Illinois, U. S. A.

Please send me your "VICTORY FOR YOU!" BOOK and EQUIPMENT FOLDER

Name \_\_\_\_\_ Age \_\_\_\_\_  
 Address \_\_\_\_\_ Apt. \_\_\_\_\_  
 City \_\_\_\_\_ Zone \_\_\_\_\_ State \_\_\_\_\_

If under 16, check here for special information.  If a discharged veteran of World War II check here.

**DeFOREST'S TRAINING, INC.**  
 CHICAGO 14, ILLINOIS

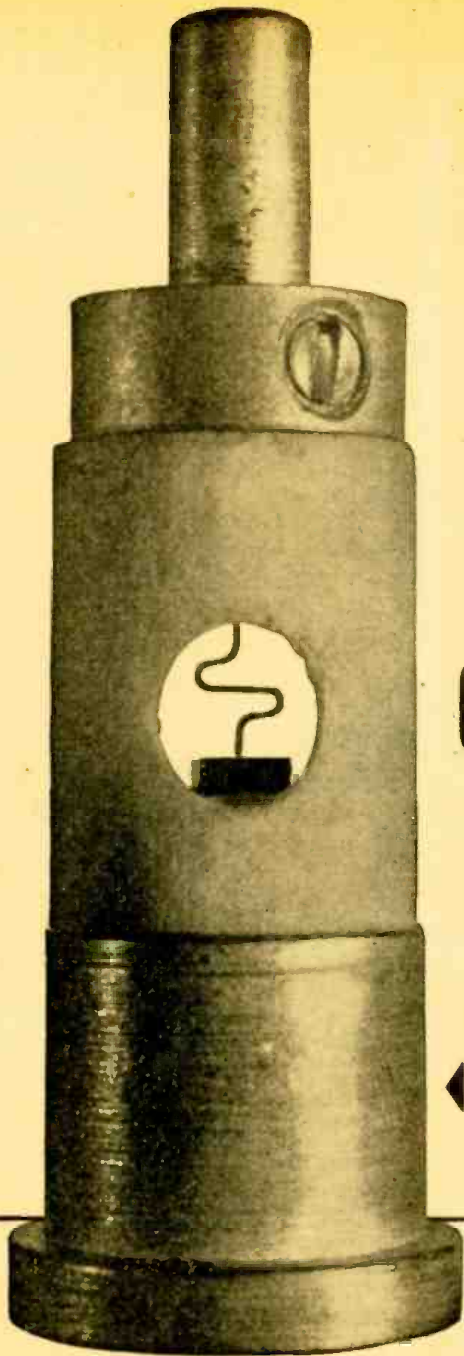

## Crystal detector—1946 model

ENLARGED  
7 TIMES

ONE INCH



Remember the crystal detector in the first radios — hunting for the right spot with a cat's whisker? For years the detector lay discarded in favor of the vacuum tube. But when microwaves came, and with them the need to convert minute energy to amplifiable frequencies, a Bell Laboratories' scientist thought back to the old crystal.

Silicon of controlled composition, he discovered, excelled as a microwave detector. Unlike the old-style natural crystals, it was predictable in performance, stable in service. From 1934 to Pearl Harbor, the Laboratories developed silicon units to serve microwave research wherever needed.

Then Radar arrived. The silicon crystal came into its own, and found application in long-distance microwave Radar. Working with American and British colleagues, the Laboratories rapidly perfected a unit which the Western Electric Company produced in thousands. It became the standard microwave detector.

Crystal detectors are destined to play a big role in electric circuits of the future. They will have an important part in Bell System microwave radio relay systems. In various forms, they may reappear in radio sets. Here again Bell Laboratories' research has furthered the communication art.

**BELL TELEPHONE LABORATORIES**



EXPLORING AND INVENTING, DEVISING AND PERFECTING FOR CONTINUED ECONOMIES AND IMPROVEMENTS IN TELEPHONE SERVICE

Grasp the **NEW OPPORTUNITIES** in

# RADIO ELECTRONICS AND TELEVISION NOW!



Modern Radio — F M broadcast and reception —  
Television — Radar — Industrial Electronics;  
power, control, communications—new equipment  
and methods demand new technical ability and  
experience. Keep up to date with the latest.

## MODERN ELECTRONIC LABORATORY FOR YOU TO USE AND KEEP

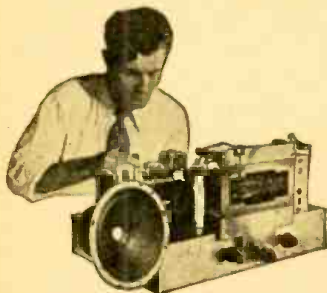

The very essence of National Shop Method Home Training is **EXPERIENCE**. You get the actual experience by working with modern Radio and Electronic equipment—building circuits and instruments. You may build a fine, long distance **MODERN SUPERHETERODYNE**, signal generator, miniature radio transmitter, audio oscillator—many other full sized, actual, operating pieces of equipment and instruments—conduct cathode ray and hundreds of other experiments. This experimental laboratory work advances with your training and you actually learn by doing. Send the coupon and get the full details of how such an offer can be made.

## Shop Method Home Training By a Great Established Resident School

Get one of the thousands of **NEW JOBS** that demand new techniques and methods in modern radio. Get your share of the **NEW BUSINESS** that servicing the new sets and equipment demands. Experts agree that Radio Television and Electronics presents the next great industrial boom!

Radio is expanding farther and faster than ever with great improvements in reception. Radar is already a 2-billion dollar a year business. No one knows yet how great the Television market will be. Electronics touches almost every walk of life—in industry and in the home.

**TURN YOUR INTEREST IN RADIO INTO A CAREER THAT WILL ASSURE YOUR SUCCESS.** Mail the coupon below for a list of the great opportunities in this field—today and in the near future.

### Get the Proper Training

The good jobs in Radio Electronics now go to the men who are equipped to handle them. It takes training and experience. National Schools, one of the oldest and best established technical trade schools in the country, makes it possible for you to get this training and experience right in your own home **IN YOUR SPARE TIME.**

Learn right! Get the latest short cuts, trade secrets, straight information.

National maintains one of the biggest resident training shops and laboratories in the United States where instructors, scientists and engineers are working constantly to improve and advance training methods. **SHOP METHOD HOME TRAINING** is a logical extension of this practical system.

A **FREE** lesson that shows you how practical and systematic—how sound, simple and easy this new training method is will be sent you without obligation. You may keep and use this lesson as you see fit. Fill out and mail the coupon below.

### Investigate this Proposition

Where do you stand today in modern industrial progress? What does the future hold for you? You owe yourself this opportunity. It may never come again. With National training **YOU GET AHEAD FAST**—you may step into a good position or start a business of your own, with little or no capital, even before you complete your National course.

Fit yourself for a career of independence, good earnings, a lifetime of success and security in one of the fastest growing fields in the World. But make up your own mind. Get the information first hand. Put your name and address on the coupon and mail it today.

## FREE LESSON



## Get This Book FREE

This big book presents the facts about the field of electronics and your opportunities in it together with full information about the advanced National Training. Read it and make up your own mind that National Training will equip you for a great future. No salesman will call on you from National. The book is **FREE** with your sample lesson. Send the coupon or write.



## See What National Training Has Done For These Men!

National Shop Method Home Training wins good jobs, independence and security quickly. Take the word of National men who have established records in their favorite Radio, Television, or other branches of Electronics:

**Joseph Grumlich,** Lake Hiawatha, New Jersey writes: "My latest offer was \$5,800.00 as Radio Photo Engineer but I'm doing well where I am now engaged. I am deeply indebted to National."

Here's a statement from **R. R. Wright,** Blackfoot, Idaho: "Due to my training at National I was selected to instruct in the laboratory work of Navy and Marines."



From **O. K. Ivey,** Washington, D. C., comes this endorsement: "I believe National offers the best course to be had. Keep up the good work."



**Robert Adamsen,** Kearney, Nebraska, National graduate, has two radio jobs—makes a double pay as a radio instructor and as engineer at Station KGFV. He writes: "I am proud of My National training and appreciate the cooperative spirit."



Read what hundreds of other enthusiastic students have written about National Training. Send in your coupon today.

## NATIONAL SCHOOLS

LOS ANGELES 37, CALIFORNIA EST. 1905

### MAIL OPPORTUNITY COUPON FOR QUICK ACTION

National Schools, Dept. RC-8  
4000 South Figueroa Street, Los Angeles 37, California

(Mail in envelope or paste on penny post card)

Mail me **FREE** the two books mentioned in your ad including a sample lesson of your course. I understand my salesman will call on me.

NAME ..... AGE .....

ADDRESS .....

CITY ..... STATE .....

Include your zone number

Check here if veteran of World War II

**SILVER**

**"VOMAX"**

**904  $\frac{C}{R}$  BRIDGE**

**"SPARX"**

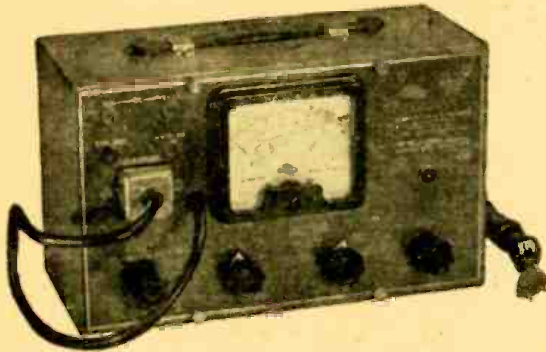

"VOMAX" is more than a multi-meter . . . more than volt-ohm-db-milliammeter . . . more than r.f. vacuum-tube voltmeter of laboratory instrument caliber. "VOMAX" is all of these things. Born out of six years of military research and production, it is new as today. Backed by a name famous for over 35 years . . . designed by radio's only International Grand Prize winner, "VOMAX" is the standard of comparison.

RADIO MAINTENANCE engineers checked and rechecked the market for the best possible meter . . . most-used instrument in all radio service . . . to serve as heart and core of its new "Modern Test Bench." They selected "VOMAX". Your efficiency and profits will be greatest when you, too, use "VOMAX". Outstanding . . .

tested and sworn to by thousands of serious service technicians . . . ordered and reordered by the U. S. Bureau of Standards, the Naval Research Laboratory, Western Union . . . used by Sperry, Monsanto Chemical, DuPont, F.C.C. Grand Island monitoring station, C.A.A., Naval Ordnance Depots, Lapp Insulator, Stackpole Carbon, Fairchild Aviation, etc., etc. This is positive proof that "VOMAX" is the meter you must have to top smart competition. Follow the recommendation by Bendix to all BENDIX RADIO distributors and dealers . . . "Use "VOMAX". It's better than we hoped."

**Only \$59.85**



Model 904 Capacitance/Resistance Bridge.  $\frac{1}{4}$  mfd/ohm thru 1,000 mfd/meg-ohms; 0-50% power factor; 0-500 volt adjustable internal polarizing voltage; 0-10 and 0-100 ma. electron-ray leakage current meter; measures resistance, capacitance under actual operating voltages! Also recommended by Bendix. Only \$49.00

"SPARX". Visual/aural dynamic signal tracer; 20 cycles thru 200 mcs.; new crystal rectifier r.f./a.f. probe; 65 db. a.f. amplifier; dynamic speaker Tests speakers, phono pick-ups, amplifiers, receivers from antennae thru speakers; determines presence of operating voltages, hum. Checks individual circuits and overall performance and quality quickly and positively. Only \$39.90



Get a copy of June, 1946 RADIO MAINTENANCE at your favorite jobber—or send 25c to 460 Bloomfield Ave., Montclair, N. J., for radio's newest 100% service magazine. Read all about "VOMAX" in it.

Send penny post-card for new, hot-off-the-press, catalog describing these important, fresh, postwar measuring instruments, plus 3 new communication receivers, 2 new transmitters, factory built and kits, condensers, coils, sockets, new "frequency-meter" 5 thru 500 watt, 6-band transmitting inductor, keying and quality monitor, new AM and FM signal generator covering 90 kcs. thru 170 mcs. on fundamentals! See your favorite jobber at once, for demand far exceeds supply.

OVER 35 YEARS OF RADIO ENGINEERING ACHIEVEMENT

*McMurdo Silver Company*

1249 MAIN STREET • HARTFORD 3 • CONNECTICUT  
IN CANADA—MC MURDO SILVER DIVISION, GENERAL RADIONICS, LTD. 465 CHURCH ST.—TORONTO, ONTARIO, CANADA.



# TELEVISION

## **Is Television Here?**

You will find the answer to that vital question in your newspapers, in magazines, in the long list of applicants for Television broadcasting licenses, in the announcements of low price receivers by leading manufacturers.

## **Are You Prepared?**

Hundreds of alert young men are training now at Television Center, the lake shore laboratories of the American Television Institute. Many have had no previous radio experience. Others are radio technicians and engineers who are convinced of Television's future.

## **Prepare the "American" Way**

American Television Institute's staff is headed by internationally known radio and television pioneers. Extensive new television studios are maintained. Equipment includes the new Image Orthicon, the television camera that "sees in the dark." You are invited to come and see what we believe to be the finest Television training laboratories in the world.

New classes are forming every week.

## **American Television Institute**

433 E. Erie Street, Chicago 11, Illinois

**GOVERNMENT APPROVED  
FOR VETERAN TRAINING!**

### REQUEST FOR FREE INFORMATION

AMERICAN TELEVISION INSTITUTE, Dept. A  
433 East Erie Street, Chicago 11, Illinois

- Please send me complete details of your Television training.
- I am a veteran.

NAME.....

ADDRESS.....

CITY & STATE.....

**THE NEW, COMPACT  
SUPER-SENSITIVE**

*Analyzer*

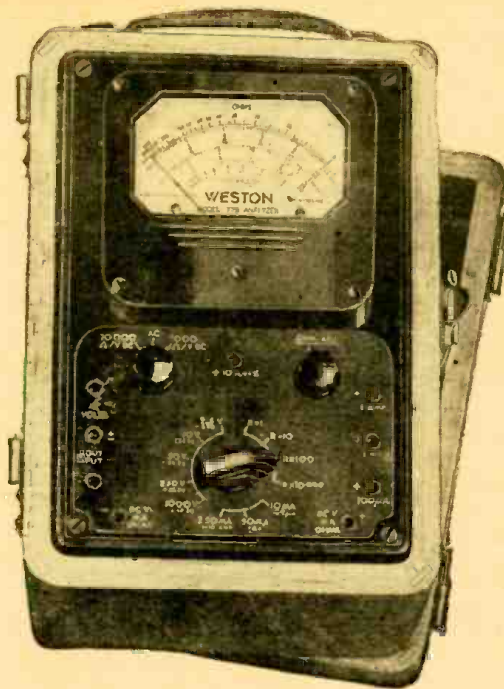

# Weston

## MODEL 779

*Model 779 is designed for use with WESTON Socket Selectors which facilitate checking tube circuit conditions — and with WESTON Televerters for DC voltage measurements up to 10,000 volts.*

Extreme compactness and lightweight—dual DC voltage sensitivity of either 1000 or 20,000 ohms per volt — five AC and DC voltage ranges, seven DC current ranges, four DC resistance ranges, and five decibel ranges — all carefully selected to meet the broadest requirements of testing and maintenance —precision WESTON resistors throughout—large 50 microampere WESTON meter — temperature compensated including AC ranges — size only 6 $\frac{3}{8}$ " x 9 $\frac{1}{8}$ " x 4 $\frac{7}{8}$ " — furnished in rugged, solid oak carrying case.

Weston Electrical Instrument Corporation, 599 FrelInghuysen Avenue, Newark 5, New Jersey.

## Weston Instruments

Albany · Atlanta · Boston · Buffalo · Chicago · Cincinnati · Cleveland · Dallas · Denver · Detroit · Jacksonville · Knoxville · Los Angeles · Meriden · Minneapolis · Newark · New Orleans · New York · Philadelphia · Phoenix · Pittsburgh · Rochester · San Francisco · Seattle · St. Louis · Syracuse · In Canada, Northern Electric Co., Ltd., Powerlite Devices, Ltd.

# WHY NO "POSTWAR" RADIOS?

## *No Super-Radios Will Be Available For a Long Time*

**A**N INCREASING number of letters from readers continue to reach us, expressing puzzlement as to why the super-ultra radio sets, glibly promised by many radio set manufacturers during the war, are not available now. Many of the writers, who are holding back orders for new radio sets, cannot seem to understand why such sets are not forthcoming. Here is a sample of what readers have in mind:

*"Editor, RADIO-CRAFT:*

*"Where are all those fancy radio models which were promised us by the advertisements of radio set manufacturers, two years back, in the midst of the war? This is written during the early part of June, 1946, one year after V-E Day. The new models we see are radio sets that were current in 1942, the same old types, with one exception—they are now much more expensive.*

*"Where are all those promised improvements? Where are the compact combination radio-television FM sets? Where are all the great mysterious war inventions that were to be incorporated into post-war radio receivers? The fancy ads hinted that new radar techniques and other 'secret war inventions' were to be incorporated into new radio sets 'just as soon as the war was over.' Where are they? (And by the way, where are the postwar pocket and vest-pocket radios?) I have purposely refrained from buying two new sets, which I need badly, thinking that I would get something better than just a 1942 model. Perhaps you can tell us what's what.*

*"C. G. LITTLE,  
"San Francisco, Calif."*

The answer to this and many other similar questions is extremely simple. It can be expressed in one single word: **ECONOMICS.**

Having talked with a number of radio set manufacturers, the answer to why most of the sets now coming out show really little improvement on 1942 sets is:

When the radio set manufacturers received the governmental order to stop manufacturing radio receivers in 1942 they all complied with this directive. They went into war work and carried on the heavy load of turning out the tools of war with which victory later was won. Make no mistake about it, the radio industry deserves great credit for doing what it did, because without radar and all the other radio war inventions in which America excelled, the war might still be on!

When the stop order came in 1942 all radio manufacturers had large inventories of parts and components

on hand, which for the most part could be used only in civilian radio sets. These inventories were stored away. The materials were not scrapped or otherwise used. When reconversion day came these inventories proved a godsend, giving the radio-hungry public at least some receivers otherwise unobtainable.

These inventories were not very large (with perhaps a few exceptions) and the first sets that arrived on the market were really 1942 models with a few new parts thrown in. But the radio set manufacturers were still tooled up for 1942 radios. Not having 1946 tools, as these could not be produced at short notice—even if the necessary labor had been available, which it was not—most radio set manufacturers proceeded for purely economic reasons to turn out pre-war receivers.

Many laymen, not acquainted with manufacturing procedure, do not understand that even in normal times it takes over a year to produce a new radio set.

New tools must be made; new molds and dies for cabinets must be created; new orders must be placed with parts manufacturers for individual components which the set manufacturer may not make. All this refers to normal times when help and materials are readily available.

In the country's present chaotic condition, where due to strikes and other reasons conversion has proceeded at a snail's pace, it is unthinkable for the average set manufacturer to project an entirely new receiver from the ground up. Many manufacturers who normally would have had entirely new models on the market now were forced to give up the projects because of shortages of materials and labor. This situation may well prevail for another year and more.

The harassed radio manufacturers today think that the public should be grateful that it gets radios at all, even if they are of the 1942 vintage. The same situation prevails in many other lines, as for instance, automobiles. Here—for the same reasons—1942 models are now coming on the market, and while there may be an improvement here and there, basically the cars are still 1942 models. The revolutionary new cars promised during the war so far have not materialized and it will take some time before they become available.

In radio set manufacture too it is doubtful whether radically new receivers will be manufactured for some little time to come.

Just to give one example of what happens when a new manufacturer attempts to come out with something revolutionary, we cite a case with which we are acquainted.

*(Continued on page 781)*

# RADIO-ELECTRONICS

## Items Interesting

**FLYING MAGNETOMETERS** were highly successful submarine detectors, it was revealed last month by Bell Telephone Laboratories. Though radar could not discover a submerged submarine, the great mass of iron affected a detector of magnetism as strongly through water as through air. Magnetometers were trailed in a torpedo-shaped fuselage as close to the surface of the water as possible, their appearance giving them the name of "flying doodle-bugs."

Peacetime applications may be more extensive than wartime uses, Bell officials believe. The new device is to be put to work as an aerial prospector, for non-metallic as well as metallic minerals. The new device fulfills a long-standing dream of geophysicists in that it provides means for a quick large-scale survey of geological structure which scientists feel may be an important key to our natural resources.

The method is considered so promising that those in charge of Naval Petroleum Reserves have employed the method extensively in exploring for geological structures which may contain oil. Some 40,000 square miles in this country and Alaska, including part of the latter's Naval Petroleum Reserve area No. 4, have already been mapped.

In this connection, it is pointed out that the device does not actually detect oil deposits, but by mapping geological structures, indicates those peculiar areas in which oil is usually found.

Just how sensitive the device is can be appreciated from the fact that during the research a new employee of Bell Telephone Laboratories inadvertently caused considerable confusion when she neglected to mention that a small bit of an ordinary sewing needle which had broken off in her finger some years before had never been removed.

Extreme precautions had to be taken throughout the researches, even to the extent of using only brand-new, non-

magnetic tools. At times the workers had to conduct their experiments in special clothing and in stocking feet, for some garments have metal accessories and shoes have nails. Even dirty finger nails have been known to disrupt the progress.

The first successful use of the new system of instruments occurred in tests conducted in Iron County, Michigan, and later in the Adirondacks in a search for iron ore deposits for war use. Subsequent tests indicated that in addition to its value as a speedy preliminary survey tool, the new device also gives a more accurate appraisal of the geological structure of an area than that obtained by ground parties using conventional methods of magnetic exploration. Another advantage of the new device is that it draws a continuous magnetic record of the terrain over which it is flown and in so doing evens out small and relatively unimportant magnetic irregularities.

**SMALL-CRAFT DISTRESS** and emergency radio messages can be sent direct to Coast Guard stations on the special frequency of 2670 kc, it was announced last month. The newly-allotted band should be of considerable help in increasing the safety of small-craft navigation.

Persons sending in emergency messages must give their own call signal, their boat's number or name, its position, the nature of the emergency and the number of persons who are aboard, authorities emphasized.

**TELEVISION PREFERENCES** of prospective purchasers are for color and a reasonable-sized screen, according to the Sylvania continuing survey of radio markets. Presenting the latest section of the survey, Frank Mansfield, Director of Sales Research for Sylvania, pointed out that the results could not be taken too seriously. They indicate only what people think they want, not what they will actually purchase some months hence. As only sixteen percent of the people interviewed have actually seen television, their ideas might change greatly.

Asked if they would prefer black-and-white or color, 72 percent wanted color, 26 percent preferred black-and-white, and only 2 percent had no preference. Probability of increased cost appeared to be the chief objection to color, as the black-and-white proponents were those who preferred lower-cost sets.

The question on screen size was tied in with price. Interviewees were asked if they would prefer a receiver with a 3½ x 5-inch screen at \$175, 5¼ x 7¾ inches at \$250, or a large 16 x 20-inch screen at \$400. Under these conditions 44 percent plumped for the 5 x 8 screen, with 12 percent going on record for the smaller one, and 25 percent who would be satisfied only with the large 16 x 20-inch pictures.

The survey, which was confined to urban prospects, brought out a number of other interesting points. Twenty-six percent of the individuals queried definitely intend to buy televisions as soon as they are available, with another 18 percent planning—but not definitely—to purchase. Asked what they planned to pay for a television receiver, more than half felt that \$150 to \$250 would be a reasonable price. When not tied in with a price consideration screen-size preferences were toward larger pictures, more than 60 percent preferring a frame 10 x 15 inches or bigger. Finally, 77 percent wanted the television screen incorporated in the set, with only 20 percent expressing preference for a wall screen, or projection-type televisor.

**REPLACEMENT TUBES**, as well as tubes for the export market, will soon be available in quantity sufficient to meet the demand, it was stated last month. The optimistic prediction was made by M. F. Balcom, chairman of the tube division of the Radio Manufacturers Association. Speaking at the association's convention in Chicago, he told members that, while the tube industry was still not out of the woods, it should be able to handle the replacement and export markets in the closing months of this year.

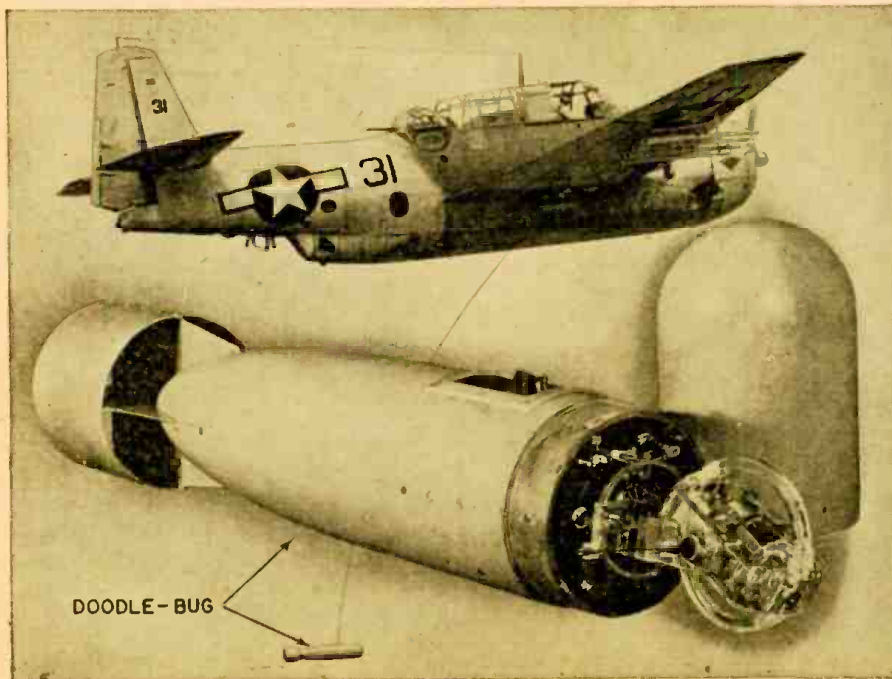

Front—Closeup of doodle-bug. Rear—How it is flown from a plane.



# MONTHLY REVIEW

## to the Technician

**TELEVISERS** plan an important exhibition of the latest in the art at their next annual conference, it was stated last month by Ralph B. Austrian, chairman in charge of the event.

"The Conference and Exhibition of the Television Broadcasters Association, which will be held in New York, October 10 and 11, will be an industry affair, designed to acquaint broadcasters and others with progress made in television during the war and to reveal for the first time the latest in video equipment—receivers, transmitters, camera units, tubes, lighting fixtures, etc.," Mr. Austrian asserted.

"Advance demands for display space indicate that the Jade and Basildon Rooms, as well as the Astor Gallery at the Waldorf, will be filled with an array of eye-compelling exhibits," he continued. "We anticipate that a record crowd of nearly 2,000 will register for this function."

The National Electronic Radio & Television Show, scheduled by private interests at the Grand Central Palace, New York, beginning October 14, will give the general public an opportunity to glimpse the latest in television receivers and electronic equipment.

**FIFTY-TWO PERCENT** of all television station applicants queried in a recent survey are all out for black and white, it was disclosed last month by Judy Dupuy, television author and editor. Sixteen percent are strongly in favor of color, and the others prefer to watch developments before taking a stand one way or the other.

Typical of the replies from proponents of black-and-white was that of the *Times-Mirror* Co. of Los Angeles:

"We believe that the present development of black-and-white television is sufficient to insure public acceptance, providing the program material is sufficiently good to hold such attention. We believe, however, that with the advent of color, if and when it is perfected, greater public attention will be directed to the 'upstairs' channels."

A typical color advocate was the Yankee Network, which stated it was filing for three u.h.f. experimental stations: "There is nothing the matter with black-and-white *per se*. It is our conviction that the 'upstairs' is the place for television, and will ultimately permit better definition and color."

WJR, the Goodwill Station of Detroit, Michigan, another color advocate, replied: "We are of the opinion that color tele in the high frequency band will become the standard broadcasting service. When it reaches a sufficient stage of development, we intend to enter color television broadcasting."

**ANTENNA TOWERS** should be placed in cities, rather than in isolated places, for greatest safety. Thus testified William J. McKenzie, chief of the aids and hazards staff of CAA flight operation, last month. He pointed out that planes normally avoid areas of tall buildings and dense population, while a tall tower in open country might be a great hazard in fog.

McKenzie testified in opposition to a House bill which would ban construction of television towers in Washington residential areas. His testimony followed a warning to the committee by J. R. Pople, TBA president, that the legislation would "retard television installation throughout the country." He said the "pattern" established in Washington might spread to other cities throughout the country.

**RADIO COMMUNICATION** in the Super-high frequency field at 21,900 megacycles, a new record high for amateurs, was completed by two amateur operators at Schenectady, N. Y., last month.

Dr. A. Harry Sharbaugh, Jr., and Robert L. Watters, both scientists in the General Electric Research Laboratory, communicated across 800 feet, using high frequency waves approaching the length of the longer light waves.

First amateur invasion into the super-high frequencies of wartime radar was reported a few months ago at 5,300 megacycles when the Federal Communications Commission first assigned these bands to amateur operators. 21,000 mc is the highest "ham-band" below the 30,000-mc ceiling, above which amateur operation is unrestricted.

**RESERVATION** of one FM channel out of every five was announced by the FCC last month. The reservation is based on the FCC's last year's allocation plan, assigning between 1,500 and 1,600 channels to metropolitan areas.

"The object of this policy," the FCC commented, "is to permit an equitable distribution of FM frequencies, pursuant to Section 307 (B) of the Communications Act. If a policy of reserving every fifth channel were adopted, each area could have a maximum of four stations assigned to it at this time."

"However, provision is made for the future consideration of an applicant for an FM station in an outlying city which has not applied at this time, if at least five channels are indicated for the area. The policy thus permits the establishment of FM service in every area and yet prevents an unequal distribution of FM channels among the various communities."

**JOHN L. BAIRD**, "father of television," died June 14 at his home in Sussex, England. His age was 58. He had been actively engaged in work and research up to the beginning of his final illness.

Mr. Baird gave the first demonstration of true television before the Royal Institution of Britain in January, 1926. In 1928, he successfully transmitted television images across the Atlantic. A selected group of experts sat in the basement "shack" of Robert M. Hart, amateur radio operator of Hartsdale, N. Y., and saw the images of a man and woman televised from Baird's London laboratory. In September, 1929, the



British Broadcasting Company began a regular television service with the Baird system.

His early work with television was carried on in spite of the worst two obstacles an inventor can face—lack of money and lack of prestige. Poor and unknown, he was in 1923 down to his last ten dollars. A meeting with an old friend, Capt. O. S. Hutcheson, resulted in raising enough money to carry his experiments on to success.

Work was being carried on by other television experimenters in the meantime—notably by C. Francis Jenkins and Lee DeForest in America. Moving pictures in silhouette form were sent by these experimenters, but it remained to Baird to transmit the first real "live" television images.

Mr. Baird has other inventions to his credit, and during the war invented the noctovisor, a device for seeing in the dark by infra-red rays. A new Baird color television system was described in *Radio-Craft*, December, 1944. Called by him "Telechrome," it produced color pictures without moving mechanical parts. His latest television improvement was demonstrated at London's Savoy Hotel a week before the inventor's death. Scenes from the British victory parade were televised on the world's largest direct-viewing screen—21 by 23 inches.

# ARMY SIGNAL ASSOCIATION

## *New Organization Welcomes Communications Men*

I AM grateful for this opportunity to describe for the readers of RADIO-CRAFT the newly formed Army Signal Association and to welcome as members all present and former members of the Armed Forces and civilians who are American citizens and interested in its objectives.

The primary purpose of the Association—a purpose which carries a strong appeal to men and women of patriotic

vision—is the safeguarding and strengthening of our national security.

This means that we will do our utmost to keep our country in organized readiness to meet external aggression by quick mobilization of trained men, superior weapons and essential industries, integrated into an effective instrument of armed defense.

To this end the Army Signal Association intends to preserve and foster the

notable spirit of cooperation and good will which flourished during the war among the various branches of the Armed Forces and the personnel of industries—both manufacturing and operating—in the fields of communications, electronics, motion pictures and photography. This vast reservoir of good will and mutual understanding will be utilized to assure cooperative aims and efforts between scientists, inventors, engineers and manufacturers in civil life and personnel of the Regular Army, National Guard, Organized Reserve, and affiliated units concerned with communications preparedness.

One of the principal lessons learned from the recent war is that the security of our Nation depends—in great measure—upon our maintaining a positive leadership in scientific research and development and their application to military problems.

Stressing the vital importance of continuous cooperation between civilian science and military agencies, General Dwight D. Eisenhower, Chief of Staff, said in a recent speech:

“As you well know, research is not a commodity that the Army can buy at a quoted price and have delivered to its warehouse in properly sized and marked parcels. A weapon already in existence can be ordered, but research is a technique where results cannot be predicted.

“Military training does not prepare adequate numbers of men in that technique. Nor should the Army be forced to depend on its own efforts to develop the best guarantees of security, so long as we have at our door, within the democracy of which the Army is an essential part, the vast technical and scientific resources of civilian life. Cooperation between civilian and military agencies will assure us the finest in scientific research.”

A major objective of the new Association will be full encouragement of research and development programs undertaken by private, educational and research organizations in conjunction with the laboratories of the Armed Forces in order that continuous study and integration may be assured.

Other objectives are to render practical and effective assistance in maintaining an efficient personnel—military and civilian—for the Army and to commemorate the wartime services of American science and industry.

*(Continued on page 783)*

### ★★ MAJOR GENERAL HARRY CLYDE INGLES ★★



Harry C. Ingles was born in Pleasant Hill, Nebraska, on March 12, 1888. Following graduation from the United States Military Academy, West Point, New York, he was appointed a second lieutenant of Infantry on June 12, 1914, transferring to the Signal Corps in 1920.

General Ingles has had unusually wide service and experience in the Army, including Director of the Signal Officers' Training Camp during World War I; Signal Officer of Divisions, Corps, and Armies; command of Signal companies and Signal battalions; Director of the Army Signal School, Fort Monmouth; Instructor in the Army

Command and General Staff School; duty on the War Department General Staff; Chief of Staff, Caribbean Defense Command; Commanding, Panama Mobile Force; Deputy commander, European Theater of Operations; and Chief Signal Officer of the Army.

He holds a Bachelor of Science Degree from the United States Military Academy and honorary degrees of Doctor of Engineering from the University of Nebraska and the Brooklyn Polytechnic Institute. He is a graduate of the Army Signal School, Command and General Staff School, and the Army War College.

# WIDERANGE POCKET TESTER

## Measures Capacities and A.C. Amperes



Widerange Tester. Power consumption is measured through the receptacle on top.

**E**VER wish for a small pocket tester that would do a man-sized job? This meter not only covers the regular ranges, but has condenser and alternating current measuring facilities. Power-line-operated devices are easily checked for correct current drain without opening their line cords. Three switches are incorporated in the circuit to provide a minimum of test lead changes and to increase safety factor when making tests on the power line.

Selecting the meter ranges was one of the main problems. A compromise between versatility and size and cost was our objective.

We first tackled the voltage ranges. Examination of the problem revealed that a 1-volt d.c. range would be useless, as battery voltages start at 1.5 volts. A 1-volt range a.c. meter can be

used for numerous testing purposes. This range serves as an excellent output indicator across voice coils, thus facilitating receiver alignment and signal tracing.

Similar pros and cons made us design the voltage measurements to increase in multiples of ten. Reading is thus simplified by having one row of numbers on the scale instead of several. The voltage ranges thus became 10, 100 and 1000 volts, a.c. or d.c., with the addition of a special 1-volt a.c. range, as mentioned above.

Milliammeter ranges were also chosen in multiples of 10, for simple scale reading. 1, 10, 100 and 1000 milliamperes (1 ampere) will cover most service requirements.

Alternating current ranges were made to operate on the same current shunts used for direct current readings resulting in fewer switching positions, smaller size and less shunt winding. Three alternating current ranges cover measurements from 50 milliamperes to 15 amperes.

A trouble with most pocket testers is that the ohms zero adjustment has to be reset every time the range switch is moved. This bothersome procedure has been minimized to the extent that no resettings are required when fresh batteries are used. Actually the a.c. power line can be used in place of batteries, but then resistance measurements cannot be made in the absence of power lines.

Resistances are measured in three ranges: 0 to 10,000 ohms, 0 to 100,000 ohms and 0 to 1 megohm, and are all found on the same meter scale. These ranges can be extended if a 45-volt battery is added in series with a 45,000-ohm resistor and the 1-meg range, which will now measure 0 to 10 megohms.

Next on our list of ranges is capacity. For these measurements a source of standard frequency is necessary. This is obtained from the a.c. power line. Very convenient ranges available for these measurements are: .001 to .1 microfarad, .01 to 1 microfarad and .1 to 10 microfarads. These ranges fall in the same positions as the 1, 10 and 100 volt a.c. positions on the selector switch. For operation the plug must be connected to the a.c. power line, and capacity is measured between the jacks marked CAPACITY and MINUS.

To measure approximate wattage consumption, electrical equipment is plugged into the meter receptacle. Power is obtained by means of a cord which is connected to the power line.

Harold Pallatz was born in Brooklyn in 1925. Started his radio career in Metropolitan Vocational High School, at the same time running a spare-time radio service shop to put the lessons into practice. Branching off into the test instrument field, he soon found himself so busy building multi-



testers and oscillators for friends that servicing was abandoned.

The war found him working for Western Electric, doing crystal calibration, troubleshooting u.h.f. equipment and endurance-testing Navy apparatus for Bell Laboratories.

Entering the Army and receiving additional training in electronics and radar, he was assigned to aircraft radar maintenance. After designing some new test sets to facilitate these checks, was transferred to the test equipment department.

Is at present in the Instrument Laboratories of Western Electric. Hopes to continue research on a new type of television projector in the future.

Before power is applied the range and a.c.-d.c. switches must be set. Power and meter indications are obtained simultaneously by pressing the push button. For apparent wattage, current reading is multiplied by the line voltage. See Fig. 1.

It must be stressed that these readings are only approximate for a.c. wattage, as power factor is not taken into account in our calculations.

### CONSTRUCTION AND PARTS

First on the list of material is a 3-inch, 1-ma milliammeter with an internal resistance of 55 ohms. If a 1-ma milliammeter of smaller resistance is obtainable, then simply adding enough series resistance to make 55 ohms will do.

Three switches are necessary. An eleven-position, two-gang switch is re-

(Continued on page 790)



The insulated bracket holds the battery clear.

# BETTER DIRECTION FINDER

*This Radio Compass Operates on Point of Maximum Signal*

**M**UCH recent progress has been made in radio direction finding equipment. Seldom indeed does a commercial or military airplane, or ocean ship, leave its base without a radio direction finding installation.

Particularly versatile instruments are the Simon Radioguide and its military version the SCR-503-A, both of which are products of the Radio Navigational Instrument Corporation. The apparatus consists of two loops permanently placed at right angles to each other and mounted on a common axis, a 13-tube, twin-channel, superheterodyne receiver, balancing controls, sensing apparatus, and azimuth indicator. The frequency range of the instrument shown in the photo is from 200 to 2000 kc in three calibrated bands: 200 to 400 kc; 500 to 1000 kc; and 1000 to 2000 kc.

A separate control unit, and a microphone in conjunction with the direction finder circuit, provides for intercommunication, or, with those models used on ships or in ground station installations, the unit may be connected to

telephone lines so that the direction finder operator may relay and receive information.

Designed for the reception of both amplitude-modulated and c.w. transmissions and equipped with headphones for aural reception, dynamotor for plate supply from 12-14, 24-28, 32 and 110 volt direct current power sources, and interconnecting wiring attachments, this is a modern and complete radio direction finding system. It provides for complete visual indication of the angular bearing of a transmitter as well as clear aural reception—from all directions—which is substantially free of the effects of precipitation static. The loop assembly may be left in a fixed position or rotated at will depending on the desired use.

### PRINCIPLE OF OPERATION

The right receiver channel drives the right pointer of the Direction Indicator in proportion to the signal picked up by loop number one and the left channel operates the left element according to the signal picked up by loop number two.

In each channel the incoming signal passes from the loop through the loop commutator, appendage, and band switch to one section of the tuning condenser and the control grid of the detector-mixer tube (see Fig. 1). This tube changes the incoming r.f. to an intermediate frequency of 1625 kc. The i.f. output of the detector-mixer is applied to three stages of i.f. amplification after which it is fed to the second detector.

This tube does three jobs at the same time. A diode section, which is connected to one winding of the last i.f. transformer, rectifies its i.f. voltage for automatic volume control. The other diode section,

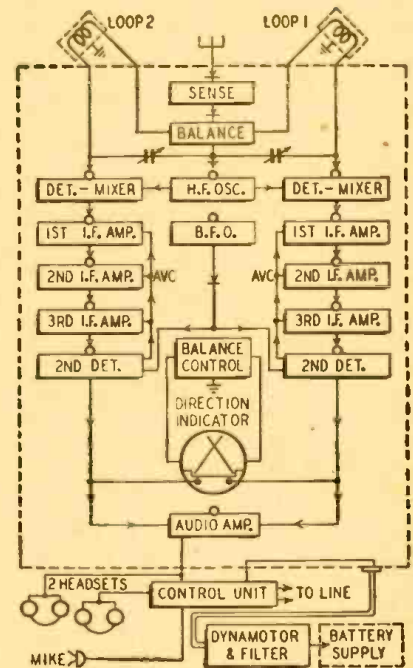
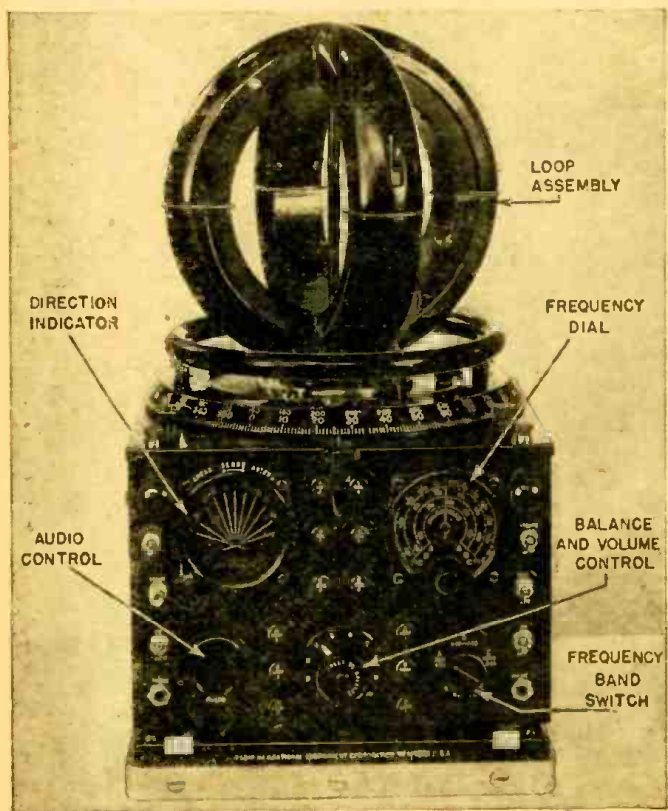

Fig. 1—The instrument in block diagram form.



The Radioguide utilizes the old principle of two crossed loops.

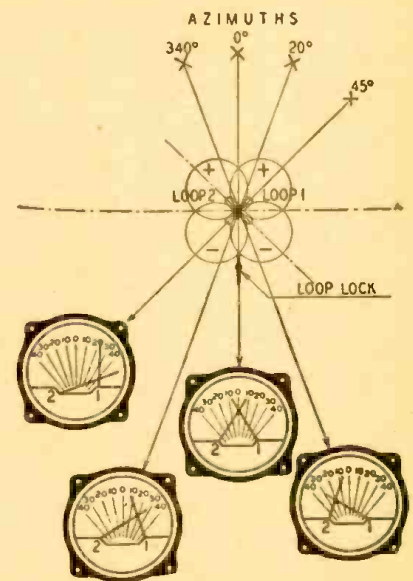

Fig. 2—Pointer positions for four bearings.

connected to a different winding on the last i.f. transformer, rectifies the i.f. voltage to produce the direct current to drive one pointer in the Direction Indicator. The rectified voltage from the meter diode section of the second detector in each channel is applied to the corresponding meter movement in the Direction Indicator, with one side of the

balancing potentiometer in series. Turning the balancing control knob while it is pressed in reduces the resistance in one side of the Direction Indicator output meter circuit and increases it in the other. Consequently one element in the Direction Indicator may be made more sensitive and the other less sensitive to equalize the overall gains of the two channels.

The pentode section of each second detector acts as a grid leak detector to provide the audio signal heard in the headphones. After passing through a resistance-capacitance filter circuit,

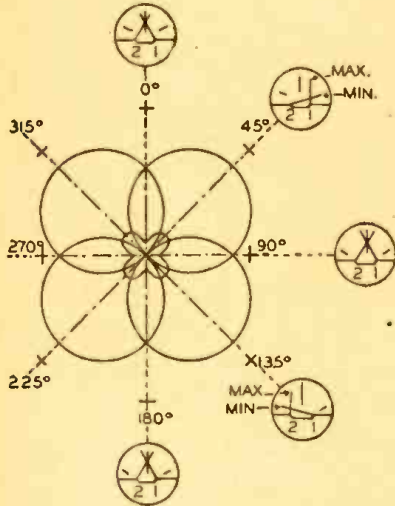

Fig. 3—Crossed-pointer response for signals of azimuths 0, 45, 90, 135 and 180 degrees. Signals from 225, 270 and 315 degrees produce the same response as their reciprocals.

which eliminates the i.f. component, the outputs of the pentode sections of the two second detectors are connected in parallel and the resulting signal is then applied to the audio frequency amplifier, after which it passes through the volume control to the output jack.

Both channels use the same automatic volume control voltage, the average of the d.c. voltage produced by the respective a.v.c. diodes. When the AVC-MVC switch is on MVC, the a.v.c. bus is grounded and its voltage eliminated.

A beat frequency oscillator is provided for c.w. reception. The CW OSC-OFF switch controls a relay which, when operated, applies plate voltage to the oscillator and couples its output to the screen grids of the two second detector tubes.

The azimuth or Direction Indicator, as it is properly called, is a crossed pointer ratio meter, the dial of which is calibrated to read in degrees to the right or to the left of a 0-degree reference mark which lines up with the nose of an airplane or ship; for ground station installations the angular bearings would be read on either side of an established line of direction, such as true north. The position of the intersection of the crossed pointers with respect to the figures on the calibrated dial visually shows the angular bearing of a radio station (Fig. 2). When the rise and fall of the meter elements is too rapid a damping arrangement may be applied through the proper switch which slows

down the action of the pointers by shunting a 500- $\mu$ f condenser across the pointer movements.

As the calibration of the dial of the Direction Indicator extends to 45 degrees on either side of the zero mark which lines up with the nose of the airplane, the movement of the intersecting pointers permits visual indications, within this 90-degree limit, of the angular bearing of a transmitter without rotating the loop assembly as shown in Fig. 2. However, bearings can be obtained from all directions by rotating the loop system and observing their position with respect to an associated 360-degree azimuth scale. The sense circuit and the inscription "AHEAD-SENSE-ASTERN" just above the Direction Indicator are used to visually indicate the sense of direction of the incoming signal.

#### THE CROSSED-LOOP ANTENNA

The very interesting antenna arrangement consists of two loops permanently placed at right angles to each other and mounted on a common axis. The response pattern, as indicated in Fig. 3, is a combination of two figure eight patterns, the four overlapping lobes of which are at a 90-degree angle to each other around the common center. Notice that bearings *can not* be obtained on a null, or point of minimum signal, as in the case of direction finders using a single loop. The minimum signal areas are eliminated by the overlapping of the four circles which form the response pattern of this type of directional antenna. Therefore, *this antenna system takes bearings on maximum signal areas*. This is important to remember for two reasons: (1) the polarization errors arising from peculiar ionosphere reflections known as *night effect* are materially reduced since both loops are effected by incoming signals; (2) as bearings are obtained on *maximum* rather than *minimum* (null) signal areas, clear reception is obtained during periods of poor weather conditions and precipitation static when dependable radio guidance is most often desired. For these reasons experienced pilots have great confidence in this direction finding apparatus. Bearings are regarded as accurate within two degrees for distances of about 150 miles.

A study of Fig. 3 shows that the signal from a 0-degree azimuth *bisects* the loops with the result that both develop equal voltages. An identical bisection, equal loop voltage condition, and identical crossed pointer indication will be noticed at 90, a third at 180, and a fourth at 270 degrees, as the loop assembly is rotated through a complete circle. Since there can be only one *sensed* direction, in this case 0, and one reciprocal indication, 180 degrees, for an incoming signal in any direction finder, then the 90- and 270-degree indications are ambiguities which are promptly eliminated by means of the BALANCING CIRCUIT. The SENSE CIRCUIT selects the sensed direction from the 0-180-degree crossed pointer indications.

The signal from the 45-degree azimuth induces *unequal* voltages in the two loops; *maximum* in loop 1, and

Edward D. Padgett was born in Pittsburgh, January 9, 1915. Received his education in the Oklahoma public schools and in the Universities of Oklahoma and Pennsylvania, after which he joined the staff of the National Broadcasting Co.

During the war was an Assistant Monitoring Officer with the FCC, later transferring to the Air Trans-



port Command Division of Pennsylvania-Central Airlines as Flight Radio Instructor. "Grounded" by severe after-effects of a yellow fever inoculation, he became associated with high-priority government radio projects.

Obtained his amateur license early in the war, so is an LSPH (licensed since Pearl Harbor) ham. Also holds first class radiotelephone and second class radiotelegraph tickets. Is a member of Phi Kappa Psi social, and Alpha Pi Mu honorary scholastic fraternities. Hopes to be back in college under the "Bill of Rights" by the time this article reaches the readers.

*minimum* in loop 2. Therefore, pointer 1 will be at a *maximum* and pointer 2 at a *minimum*. The resulting movement of the crossed pointers will be to the *right* and the position of the pointer intersection will be at 45 degrees on the right side of the Direction Indicator.

For a signal coming from the 45 degree azimuth there also will be four crossed pointer indications on the dial of the Direction Indicator as the assembly is rotated through 360 degrees. One will be at 45 degrees on the right

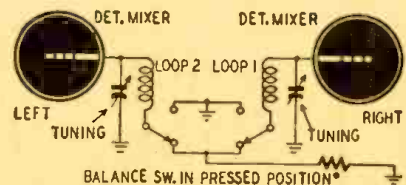

Fig. 4—Balance circuit for right-left sense.

hand side of the azimuth indicator. There will be another at 135 degrees, but this indication will be on the left side of the dial since, in this position, the incoming signal now induces a maximum voltage in loop 2 and a minimum in loop 1; pointer 2 is now driven by a maximum current and pointer 1 by a minimum current. As the loop system is rotated to 225 degrees the pointers

(Continued on page 804)

# THE "SONICATOR"

## A Short-Range Sound-Operated "Radar" For Owners of Small Boats or Yachts

OVER short distances, a simple sound-operated locating and ranging device may be as effective as radar. To the owner of a small boat who wants to "see" objects a few dozen feet away in fog or darkness, it may be even more useful. The *Sonicator* locates and indicates the distance of rocks, buoys above water, other craft, piers and other objects, up to 550 feet, through fog, darkness or smoke. Within this distance—practically below the minimum range of a radar set—lie most of the objects in which the operator of a slow-moving small craft would be interested.

Principle of the Sonicator is that of using the ordinary sound echo, a practice not unknown in inland navigation. River pilots have judged distance by the time required for an echo of the steamboat's whistle to return from cliffs or even special "echo boards" erected for the purpose. The vast amount of special skill required, as well as the possibility of mistakes in judging direction, limit the value of this method, which will not in any case show the presence of small objects such as buoys or small boats.

The Sonicator indicates both direction and distance simply and unmistakably. It sends out a 10,000-cycle shock sound wave of high amplitude and steep wave front, lasting only about one-thousandth of a second. This shock wave travels out in a narrow beam like the rays of an invisible searchlight. When it strikes any object, sound waves are echoed back in a wider beam, are picked

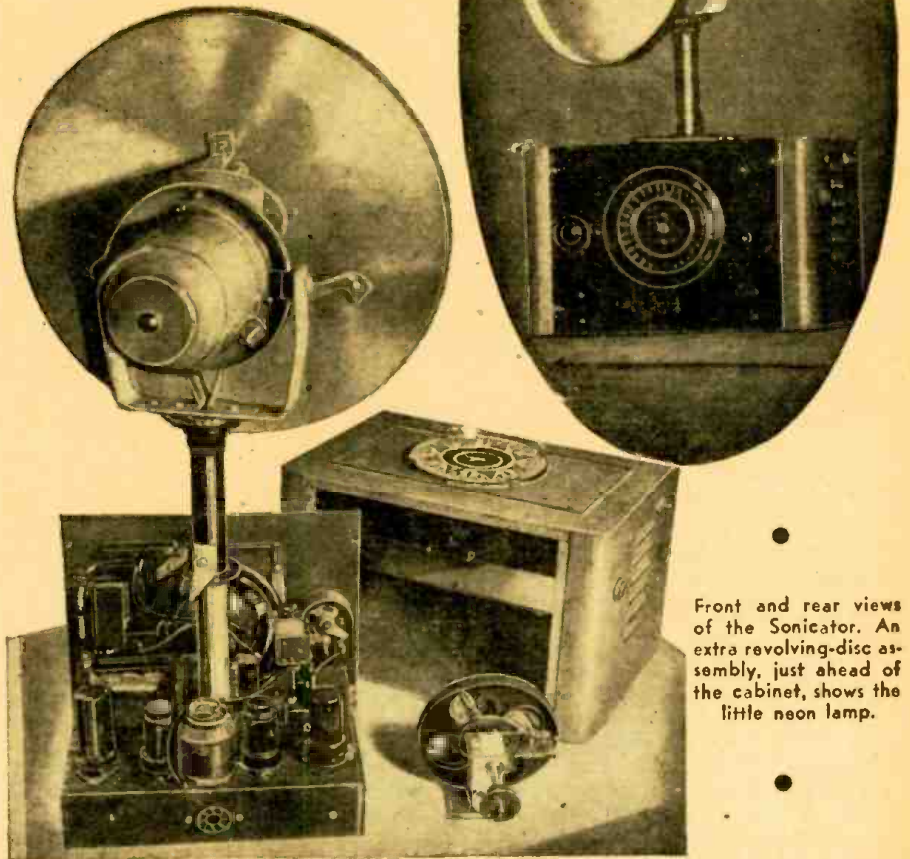

Front and rear views of the Sonicator. An extra revolving-disc assembly, just ahead of the cabinet, shows the little neon lamp.

up by a microphone, amplified and applied to an indicator which measures the time difference between transmission of the wave and reception of the echo. The apparatus itself is shown in the photo and Fig. 1.

The audio amplifier is a 4-tube type with attenuated low-frequency response though any good audio amplifier would work satisfactorily. The reflector in the experimental model is the regular electric-heater type. A frame bolted to it at three points holds the sound transmitter, which is the unit of a horn-type loudspeaker, with its opening as close to the parabola as possible. A microphone

### THE NEON-TUBE INDICATOR

is also mounted within the parabola, near the focus. The other special piece of apparatus is the indicator. This consists of a neon tube revolving behind the large dial on the panel of the instrument. This dial (of painted glass) has a clear transparent ring near the outside edge, and the edge itself is calibrated in feet. The neon tube revolves directly behind the transparent ring, and by flashing indicates the distance from the object. See Fig. 2. Direction is determined by rotating the reflector to the point of greatest response. The Sonicator will indicate several objects in line, and show the distance to each, if they are not directly behind each other.

Most important feature of the instrument is the revolving disc which carries the neon light and the switch that triggers the transmitter. The disc (a spare one of which is shown in the photo) is driven by a 6-volt phonograph motor geared down to 1 revolution per second. Its details are more clearly explained in (Continued on page 792)

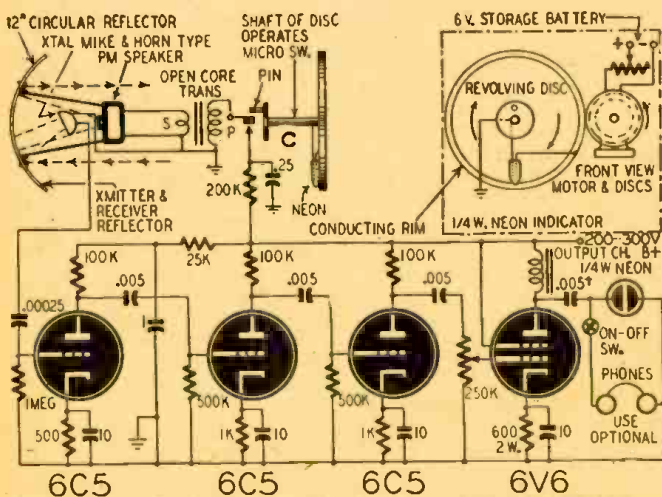

Fig. 1—The Sonicator schematic; with details of mechanical parts.

# TUBE CHECKER MODERNIZER

## Equip Your Old Tester to Check the Latest Tubes

**T**UBE checker obsolescence is a perpetual problem for the radio serviceman. Frequent purchase of a new checker is a simple, but expensive solution of the problem. When new equipment is unavailable, or when economy is a consideration, a suitable method of modernization is needed. The method described in this article was used by the author to modernize a ten-year-old Triplett Model 1503 combination tester.

The fundamental testing circuits of

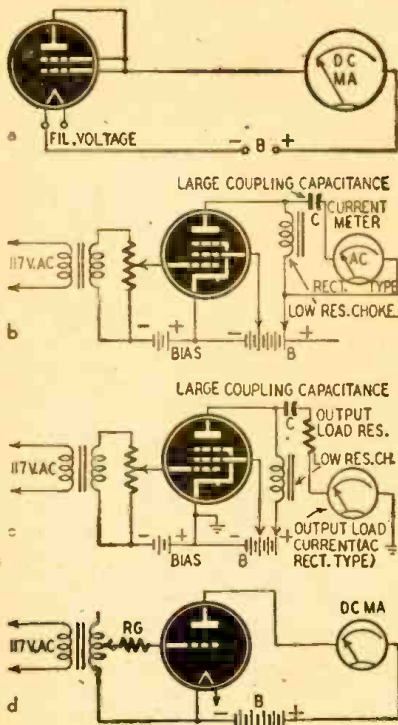

Fig. 1—Four fundamental tube test circuits.

today differ little, if any, from those of ten years ago. Obsolescence is usually caused by inadequate switching and filament supply circuits. Almost any checker can be modernized by first determining the basic test circuit, then designing adequate switching and filament supply circuits to supplement the obsolete ones. New tubes are connected through a control panel to the original test circuit; quality tests are made with the tester controls and meter; and the old circuits need not be changed. The advantages of this method are:

- 1.—Full use of the obsolete checker; therefore cost is kept to a minimum.
- 2.—Calibration required for new tube types only.
- 3.—The volt-ohm-milliammeter cir-

cuits of a combination tester are in no way disturbed. (This is important to those who wish to retain the volt-ohm-milliammeter circuits, but would like to modernize the tube testing section.)

### BASIC TESTING CIRCUITS

Tube checkers can be divided into groups according to the tube characteristic tested to indicate quality. Emission, transconductance (mutual conductance), and amplification (or power output) tests are popular. Fundamental schematic diagrams are shown in Fig. 1.

Emission testers (Fig. 1-a) measure total tube current (emission) under specified test conditions. The filament is operated at rated voltage. The cathode is connected to B-, all other elements are tied to the plate, a low positive voltage is applied, and emission is read on the meter. The test is essentially for "end of life"; it is not always an accurate indication of tube quality—a defect may cause normal emission. Emission testers are easy to construct and operate; simple circuits will bring them up to date.

A good transconductance tester provides a better test for quality. The transconductance test circuit shown in Fig. 1-b forms the basis for many. The audio choke, coupling capacitor, and rectifier-type milliammeter replace the ex-

pensive dynamometer used in laboratory testers.

The power output test (Fig. 1-c) is not as popular as the transconductance

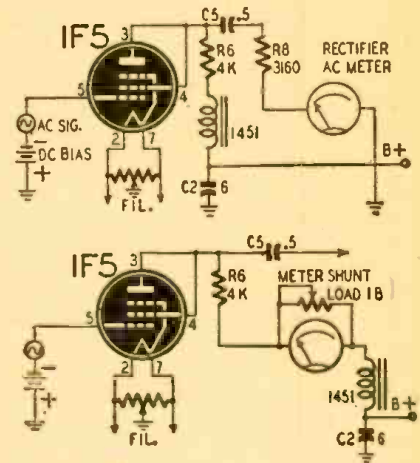
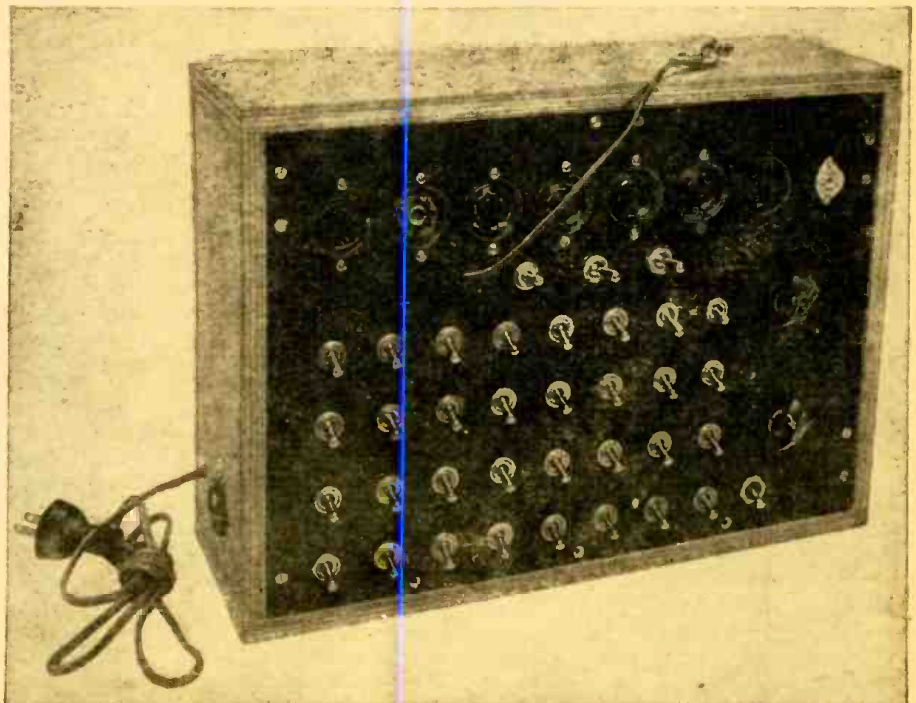

Fig. 2—Tube checked by two standard methods.

test. For power output tubes the test is a close check on quality; for voltage amplifiers, power output is an indication of the amplification that can be expected.

The transconductance of Class-B amplifiers, such as the 6N7, is difficult to check with ordinary circuits; there-

(Continued on following page)



While the array of switches may look formidable, actually only a few are used in each test.

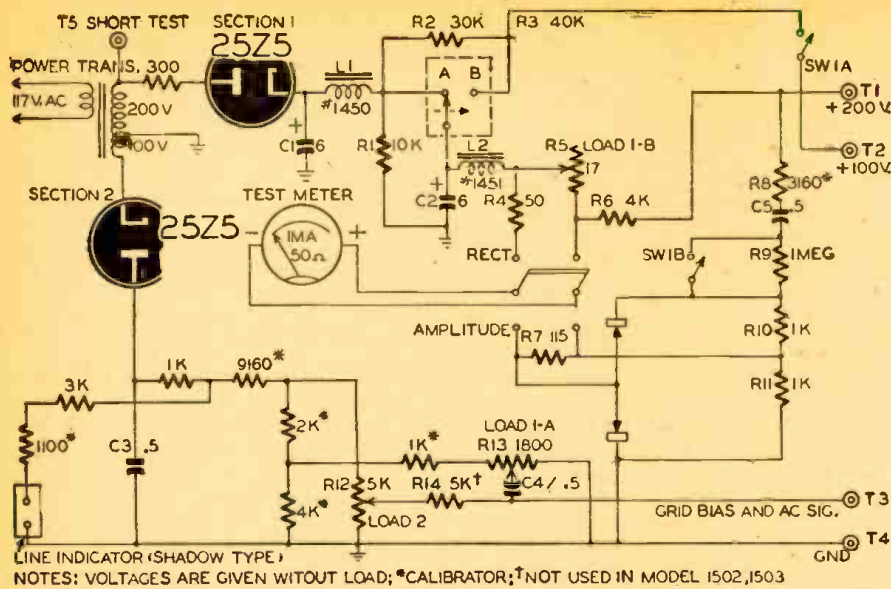

Fig. 3—Simplified diagram showing basic testing circuits of Triplet Models 1502 and 1503.

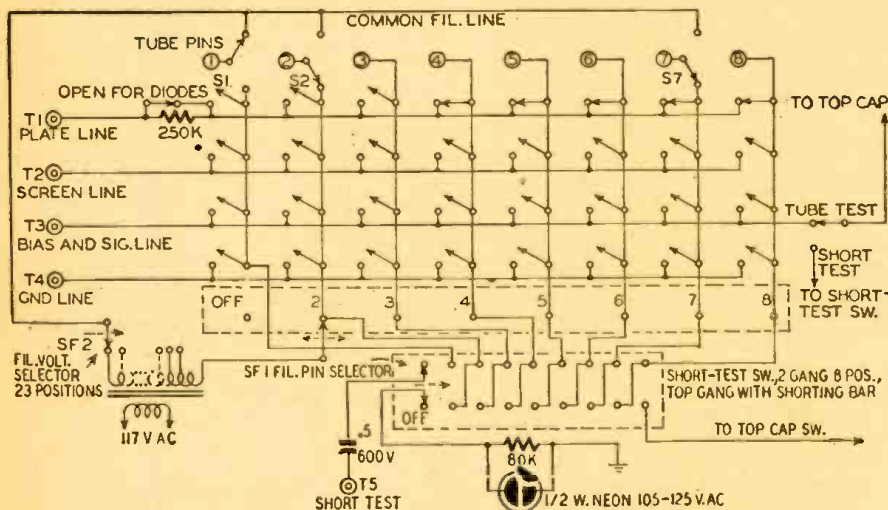
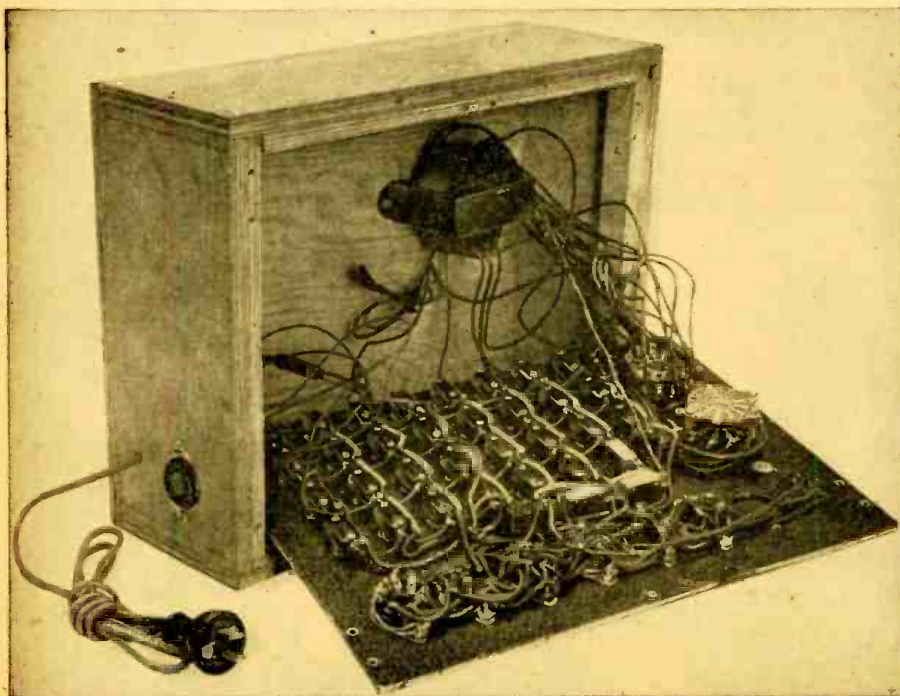

Fig. 4—Complete schematic of the adapter unit including the short-circuit testing section.



A rear view of the adapter on preceding page, showing internal construction and wiring.

fore a special power output test (Fig. 1-d) is sometimes employed.

To determine the basic circuit in an obsolete tester, isolate the circuit on the schematic. A simplified diagram of the Triplet test circuit for amplifier tubes is shown in Fig 2-a. (For simplicity, symbols represent the a.c. meter, d.c. bias, and a.c. signal circuits.) The 1F5 tube in Fig. 2-a is tested as a triode in a modified power output test circuit (Fig. 1-c). For many tubes, the Triplet tester uses the emission circuit of Fig. 1-a. For certain tubes the circuit of Fig. 2-a is used, but the meter is placed in series with the plate load to indicate plate current (Fig. 2-b).

### COMPLETE TESTING CIRCUIT

To determine supplementary circuit connections and the need for changes in the original tester, make a schematic which shows all the components that must be in operation when a tube is tested (Fig. 3). For example: the single-pole double-throw switch (within dotted lines) was added to the Triplet, so that miniature tubes could be tested. With this switch at A, the original circuit is unchanged; at B a suitably low voltage is available.

Fig. 3 shows that plate voltage is applied through choke 1450 and resistor R6; therefore a lead was run to T1, one of the base pins on a six-pin tube base used to connect the tester to the control panel. Similarly, screen voltage is taken from switch SW1-A to a second tube-base pin T2; the combined bias and a.c. signal voltages are taken from the poorly filtered rectifier circuit (25Z5, section 2) through a third tube-base pin T3. (The voltage across the resistance network is unidirectional and pulsating; the d.c. component provides bias, the pulses provide signal.)

Switches SW1-A and SW1-B are controlled by the checker VALUE push-button. These switches are normally open; SW1-A to prevent the application of screen voltage before plate voltage, SW1-B to prevent burning out the meter while the calibration controls (LOAD 1 and LOAD 2) are adjusted. *Always make certain that such protective circuits are not left inoperative when supplementary circuits are wired into the tester.*

### CONTROL PANEL CONNECTIONS

Seven tube-sockets are mounted across the control panel (See photo). From left to right they are: octal, loctal, 7-, 6-, 5- and 4-contact, and a 7-contact miniature. These sockets are connected in parallel (Fig. 4). Space has been left for an additional socket.

Three s.p.d.t. toggle switches, mounted immediately below the test sockets, connect tube pins 1, 2, or 7 through the filament voltage selector switch SF2 to the filament, or to the main bank of switches. These pins were chosen because they enabled application of filament voltage to all tubes then listed in the RCA receiving tube manual. For "full-floating" filament connections, a

(Continued on page 802)



# TRANSMITTER OUTPUT STAGE

## Simple and Efficient Final Amplifier

THE push-pull r.f. final amplifier to be described has been designed especially for use in connection with the 100-watt exciter-transmitter owned by the author. This is, of course, much more power than is needed to excite the two Taylor TW-75's, and any exciter or transmitter with an output of 30 watts would be quite sufficient. This amplifier really "loafs along" at 500 watts input and will make a fine medium-power transmitter for both phone and c.w. work. The TW-75 is a very fine tube for use in a transmitter of this size, and is also desirable because of the fact that it will stand a temporary overload of as much as 800% without releasing gas or destroying the filament emission. It is quite a common thing for the ham who is working with higher power for the first time to ruin his expensive transmitting tubes by accidentally overloading them while experimenting with the transmitter. Of course we do not mean to give the impression that the tubes cannot be damaged by excessive overloads; by a temporary overload we mean only for a few seconds at the most.

As the photographs show, the unit is built up on a standard steel panel and chassis assembly designed for mounting in the standard 19-inch rack or rack-cabinet. The plate tank tuning condenser, the two neutralizing condensers, the variable-link tank coil and its mounting assembly and the two power amplifier tubes are mounted on top of the chassis. The grid-circuit tuning condenser, the plug-in type grid coil, the grid r.f. chokes, the filament

transformer and the various other small parts are placed underneath the chassis.

The excitation power from the 100-watt transmitter's plate tank circuit, required for driving the TW-75 grids, is transferred by means of a twisted-pair link. In this particular transmitter the variable-link coil was placed in the buffer plate circuit, because it was felt desirable to have the exciter so that it could be used as a complete transmitter in itself. If this feature is not so desirable, it would be decidedly more practical to use the swinging-link coil in the grid circuit of the final amplifier.

### LAYOUT OF AMPLIFIER SIMPLE

There is nothing radical or extremely different in the layout of the amplifier. The arrangement shown here is very good from the standpoint of short leads and ease of neutralization. In fact, we went to so much trouble in keeping the layout symmetrical that we encountered a nice case of ultra-high-frequency parasitics. This particular type of oscillation is caused by the leads in both sides of a push-pull amplifier having approximately the same length, distributed capacity and inductance.

The trouble is not especially difficult to eliminate, and in our own case was removed entirely through the use of small r.f. chokes consisting of 15 turns of No. 12 enameled wire wound to a diameter of 1/2 inch and pulled out to a spacing of one diameter. These coils are self-supporting and are placed directly between the grid terminals of the TW-75s and the fixed plates of the grid

tank condenser as shown in Fig. 1. Another method of eliminating parasitics of this type is simply to use

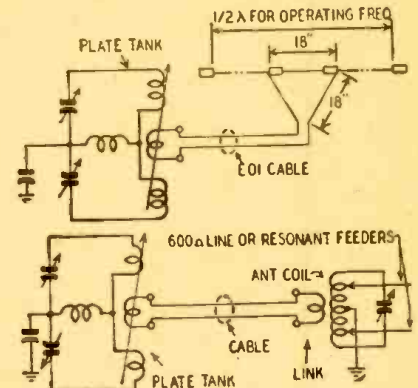

Fig. 2—Coupling circuits for 600-ohm transmission line or to a low-impedance doublet.

nichrome resistance wire, which you can obtain from an old rheostat, in place of the usual copper bus in wiring the grid circuit. This has no effect on the (Continued on page 798)

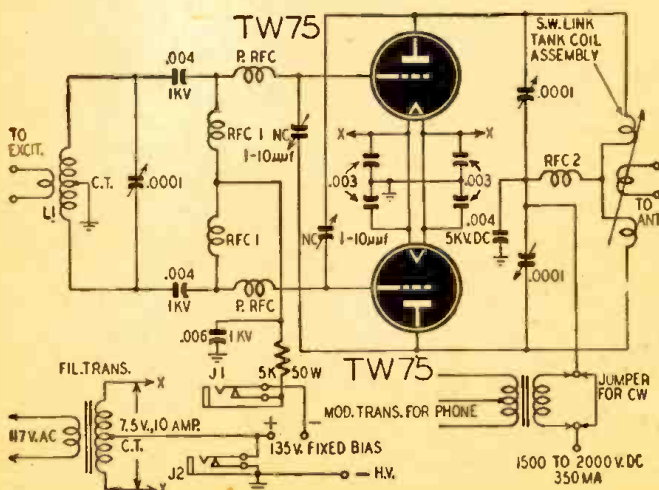
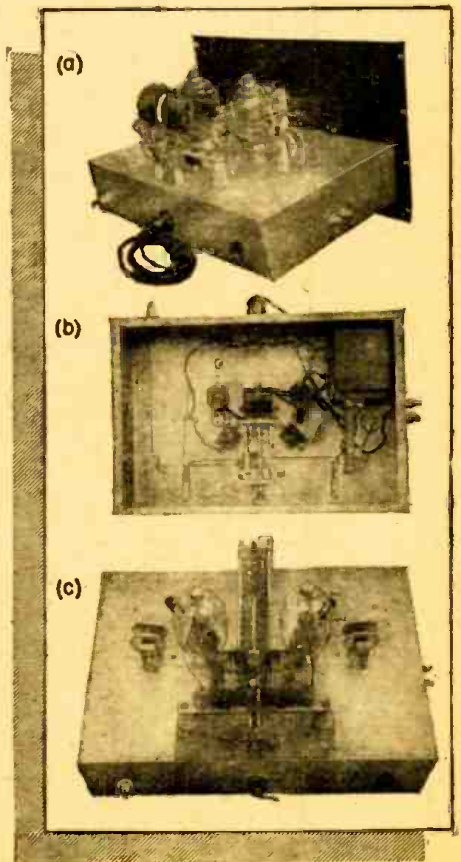

Fig. 1—Schematic of the amplifier. Built to work from an exciter of 100 watts, it uses neutralized triodes for a stable and dependable final stage.

Photo, right—Three views of the amplifier. Bottom is the front with panel removed for photograph.



# TRACER PLUS POWER SUPPLY

## Two-In-One Instrument Has Special Intermittent Prod

THE instrument described here was constructed over a year ago and has been in use in our service shop since that time. It has been the most frequently used instrument in the shop because of its flexibility and speed in locating simple or obscure troubles, especially intermittents, in radio receivers and sound equipment.

All the uses of this instrument will be apparent from an observation of the circuit (Fig. 1) and pin jack connections. Basically it consists of four sections: a power supply, an audio amplifier, a PM speaker, and a shielded test probe that will respond to r.f., a.f. or i.f. These four sections are connected so they may be used separately or in

combination, resulting in great flexibility and a number of uses instead of just the conventional one of signal tracing. For example, with the a.c. power off, the filter choke, filter condensers, bleeder resistors, output transformer and speaker may be used as substitution parts by simply making proper connections to the pin jacks.

With the a.c. power on, all power transformer voltages are available at pin jacks, also the unfiltered d.c. rectifier output and three steps of filtered d.c. voltage, 250 and 180, and one variable from 45 volts to 90 volts.

This instrument will supply plate and filament voltage to a receiver with an inoperative power supply while the r.f., i.f. and a.f. circuits are checked with the test probe. It will also supply plate voltage while servicing battery radios, making a B battery unnecessary.

Phono pickups and microphones may be checked with the audio amplifier and the audio input jack may be switched to the 6J7 driver grid or to the 6F6 output tube grid, with volume controls in both cases.

Hubert Watkins was born at Gulfport, Mississippi, December 17, 1909. Became interested in radio back in crystal detector days. Still following radio as a hobby, he began commercial servicing of radio and sound equipment in 1932, sometimes with repair organizations, sometimes in his own business. Has



held jobs as theatre projectionist, theatre manager, theatre sound maintenance. Member International Association of Theater Sound Engineers. Educated at Gulfport schools, short course at Mississippi State College and Signal Corps Training Schools. At present operating his own service business.

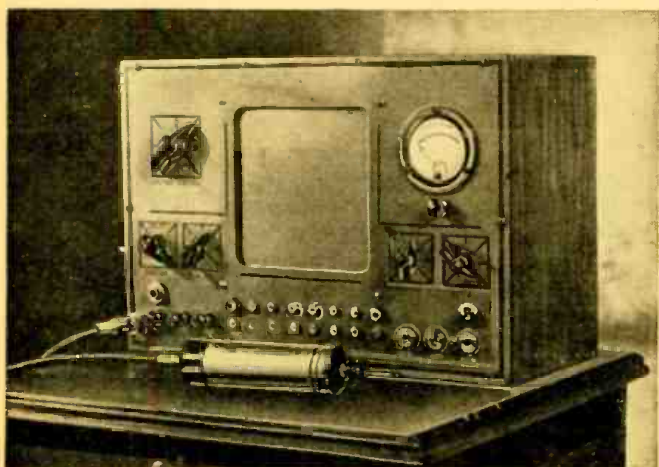

Exterior design of the equipment is distinctly modern and postwar.

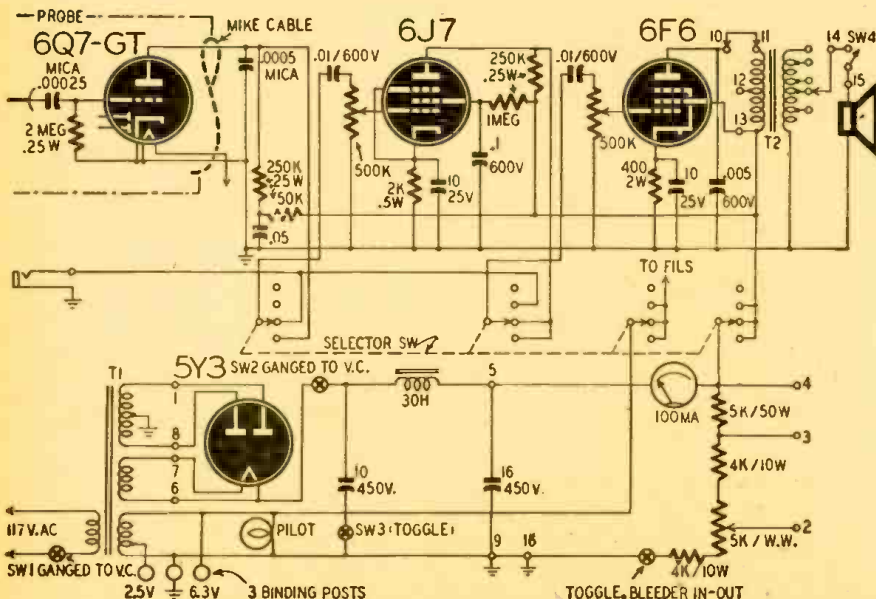

Fig. 1—Schematic of the tracer and power pack. The numbers refer to pin jacks on the panel.

The amplifier output may be fed into the built-in PM speaker, or to an external speaker, from either the 6F6 plate or the output transformer secondary. A universal output transformer is used with a rotary tap switch for matching impedance.

### CABINET CONSTRUCTION

The cabinet is constructed of plywood and is 9½ by 14 by 6 inches. It is finished with clear varnish.

The panel is tempered masonite and should be cut slightly larger than the cabinet and fastened with ten ½-in. wood screws.

The panel should be drilled as indicated in Fig. 2 and all parts trial mounted to be sure that everything fits and that one part does not crowd or interfere with another, then removed in order to paint the panel.

The panel for the instrument described was finished in silverwing gray with black border lines and indicator scales, and speaker opening trimmed in dark gray, with light gray grill cloth.

Automobile Duplicolor touch-up enamel is used, one small bottle of black and two bottles of gray being more than

enough to finish the panel with several coats. The paint is thinned with lacquer thinner and sprayed on the panel with a fly-spray gun. About twenty minutes should be allowed between coats, and care should be taken not to get the paint too thick in spots so that it might sag or run. Several thin coats are much better than one or two thick ones.

When the panel is completely dry (about thirty minutes should be allowed for the last coat to dry), polish the entire surface briskly with a soft dry cloth until it has a uniform high gloss over the entire surface.

Mount the voltage control, selector switch, output impedance switch and both volume controls. Mount a pointer knob on each shaft and with a hard lead pencil mark all switch positions and starting and stopping points of volume controls, then remove all knobs and controls. With a ruler and fine pointed hard lead pencil draw in all indicator scale designs, making double lines about 1/8 inch apart. Draw border line and speaker trim line. Cut masking tape in strips about 1/4 in. wide and mask each side of the designs, leaving only the design exposed. Trim all rough edges and irregularities with a sharp razor blade. With a small artist's brush, paint in the designs with unthinned black paint. Allow to dry, remove tape and trim any rough edges with razor blade. This makes a panel with a professional finish.

All panel parts should be mounted and as much of the wiring completed as possible before it is mounted to the chassis, as some of the connections are not readily accessible after mounting.

Any metal chassis of the approximate dimensions shown is suitable. The front apron and one inch of the top should be cut away as shown in Fig. 3.

All parts should be mounted in the approximate positions shown and wired together as shown in the diagram. Shielded wire should be used in the grid circuits. The panel is secured to the chassis by the ground binding post and the speaker On-Off switch. All leads between the two assemblies are then connected and soldered in place. This completes the wiring.

The selector switch may be any four-pole four-position switch. The one used in the instrument described was a two-deck four-pole three-position waveband switch salvaged from an old radio receiver. The stop was removed so that it could be moved one point farther, thus opening all four circuits. This is the first, or "power" position, in which all voltage is removed from the amplifier, leaving the entire output of the power supply available at the pin jacks. The voltage control is a 5000-ohm volume control such as was used in the Philco model 20 receivers.

The r.f., i.f., a.f. probe (Fig. 4) consists of a 6Q7 tube, a .00025-uf condenser and a 2-megohm resistor in a shield, connected to the amplifier with a 30-inch length of two-conductor shielded microphone cable. The shield acts as filament and cathode return for

the 6Q7 tube. The probe shield is made from an electrolytic condenser can which fits the 6Q7GT tube snugly and makes a very neat appearance. A two-conductor Amphenol microphone jack is mounted in the lower left corner of the amplifier panel, and a plug to fit this jack fitted to the end of the probe cable. Thus the probe may be removed when necessary. The prod is a 6/32 brass screw, to accommodate the special capacitor tip for tracing intermittents.

### OPERATING THE INSTRUMENT

After constructing the instrument the builder will be so familiar with the circuits that its many uses will be apparent. Therefore particular switch settings for a specific use will not be listed.

It is possible to trace the signal through the receiver from the antenna post to the voice coil, noting the gain or loss in each stage and if distortion is present, at just what point it originates. To those service men who have never used a signal tracer the results will be astounding.

This instrument is especially useful in tracking down stubborn intermittents. The special tip for the signal tracer probe for this work consists of a thin circular piece of copper or brass about 3/8-inch in diameter. A thin sheet of mica cut to fit is cemented to one side and a hex. nut soldered to the other side. This may be screwed to the probe tip. See Fig. 5.

Usually when an intermittent receiver

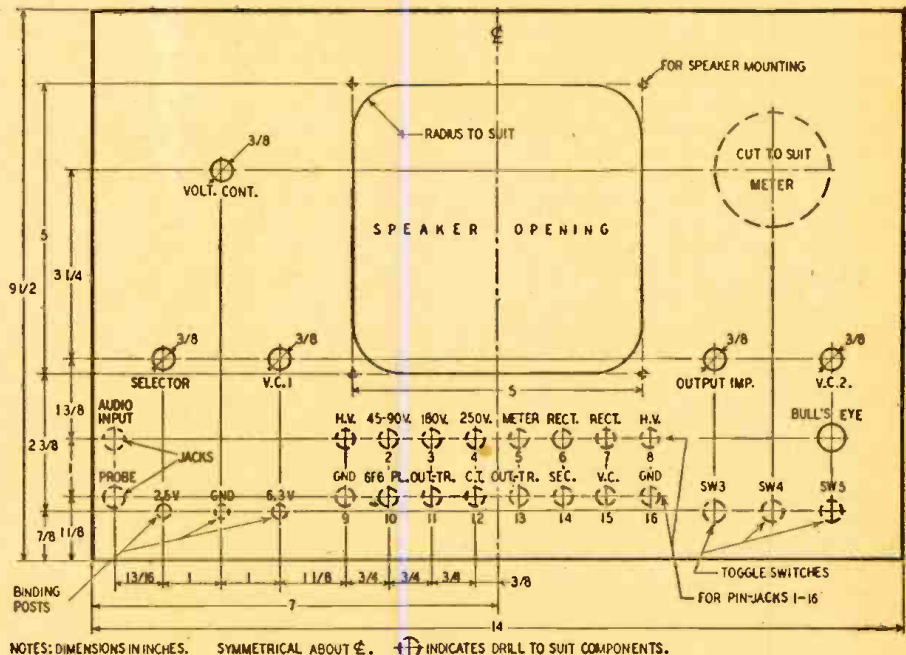

Fig. 2—The complete drilling plan of the panel may be modified to suit the constructor's parts.

Of course it will be most frequently used for signal tracing. The receiver chassis should be connected to one of the ground pin jacks with a lead fitted at one end with a phone tip and an alligator clip on the other. Several of these leads should be made up because as many as five or six leads are sometimes connected from the tracer to the receiver (as when using the power transformer for an inoperative one in a set under test).

"cuts out" the contact surge caused by touching a tube prong or any live circuit connection with a test probe will cause it to "cut in" again. It may take hours of playing time before it cuts out again, and the same thing will probably happen when another test is made.

When a receiver known to be intermittent is to be serviced it is always wise to subject the tubes and parts to mechanical shock. This will disclose

(Continued on page 791)

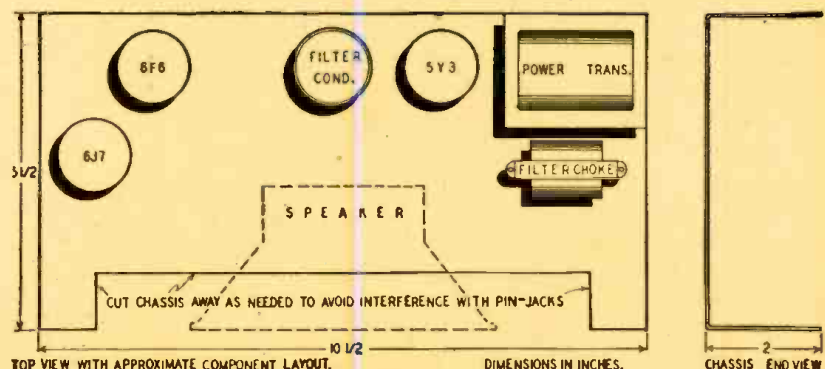

Fig. 3—Top view, showing components layout, cutaway for speaker and dimensions of chassis.

# PHOTOFACTS FOR SERVICEMEN

## A New Organization Attacks Circuit Information Problems

**T**ODAY'S radio serviceman, in common with most of us, faces new problems. The number of radio and phonograph manufacturers has skyrocketed. Where in prewar days the serviceman could get by with service data on sets of about 35 manufacturers, today he is (or soon will be) faced with the progeny of some 225 manufacturers. It is estimated that these set makers will produce some 1000 models in 1946.

Competition for his business is another problem. Many veterans, who were non-professionals before the war, were in radio work while in the armed forces. They are entering the radio service field. *There will be more radio servicemen than ever before.*

FM sets, automatic record changers and, to a lesser extent, television receivers will come in for repair with increasing frequency. Servicing will be more complex.

Even in prewar days the serviceman was troubled by inaccuracies in manufacturers' service data. This condition will not improve for some time, with many new firms staffed as they must be with some green hands in their service departments. In fact, the situation may be worse than before the war.

In an effort to meet these problems a new method of supplying radio service data has been developed by Howard

Sams & Co., of Indianapolis. Known as the *PhotoFact* service, it attacks the problems by supplying more complete and more accurate servicing data on all sets made after January 1, 1946. In addition, methods of presentation have been devised which make the material easier to use.

The plan is an improvement on a similar method successfully used by the Signal Corps during the war. Armed with detailed information on the new sets, the serviceman should be able to reduce the time spent on each job.

### THE MODUS OPERANDI

Here's how the plan will operate on a typical new set. The Blank Radio Corp. brings out their new model X. At the time it goes into production the PhotoFact organization secures one of the sets and the manufacturer's schematic. The set is analyzed by PhotoFact engineers and photographed in detail so that every part can be identified clearly. The photos are then labelled with part identification numbers keyed to a parts list. In addition, specifications of each part, including manufacturer's part number, available alternate replacement types, together with installation notes, are compiled. The manufacturer's schematic is checked against the set and redrawn and cor-

rected if necessary. At the same time, complete voltage and resistance measurements are made. Alignment procedure is checked; location of all trimmers is labelled on the parts location photos in numbered sequence corresponding to actual alignment sequence. The numbers are keyed to written alignment instructions. Finally the set is given a performance check and overall and stage gains measured. All this data is then compiled into a PhotoFact folder on the Blank Model X. The completed folder will contain from 4 to 12 pages, depending on the size of the set. Several pages of a typical folder are shown. Most set manufacturers are cooperating in the plan, and it is hoped that it will be possible to issue a PhotoFact folder on each new set within 90 days of the date it goes into production (by the time the new set guarantee has expired on the first sets sold). This time factor will be of great value to the serviceman. No longer will he be asked to service a new set for which he has no data.

### SEVERAL OTHER SERVICES

Another time saver is the information furnished on alternate replacement parts to use if manufacturer's exact replacements are not available. By listing the catalog numbers of suitable parts made by several part manufacturers, the serviceman is saved the time and bother of searching through catalogs for a part that *may* fit.

Subscribers to the service will receive the folders on new sets in groups covering 30 to 50 sets at a time. A loose leaf binder will be available to subscribers for filing the folders.

In addition to the PhotoFact folders, the organization has established an advisory service for subscribing service men. The advisory service, headed by 30 specialists in radio, radar, and radio servicing, will aid in solving subscribers' problems in servicing techniques, shop operation, promotion and all other phases of successful business operation.

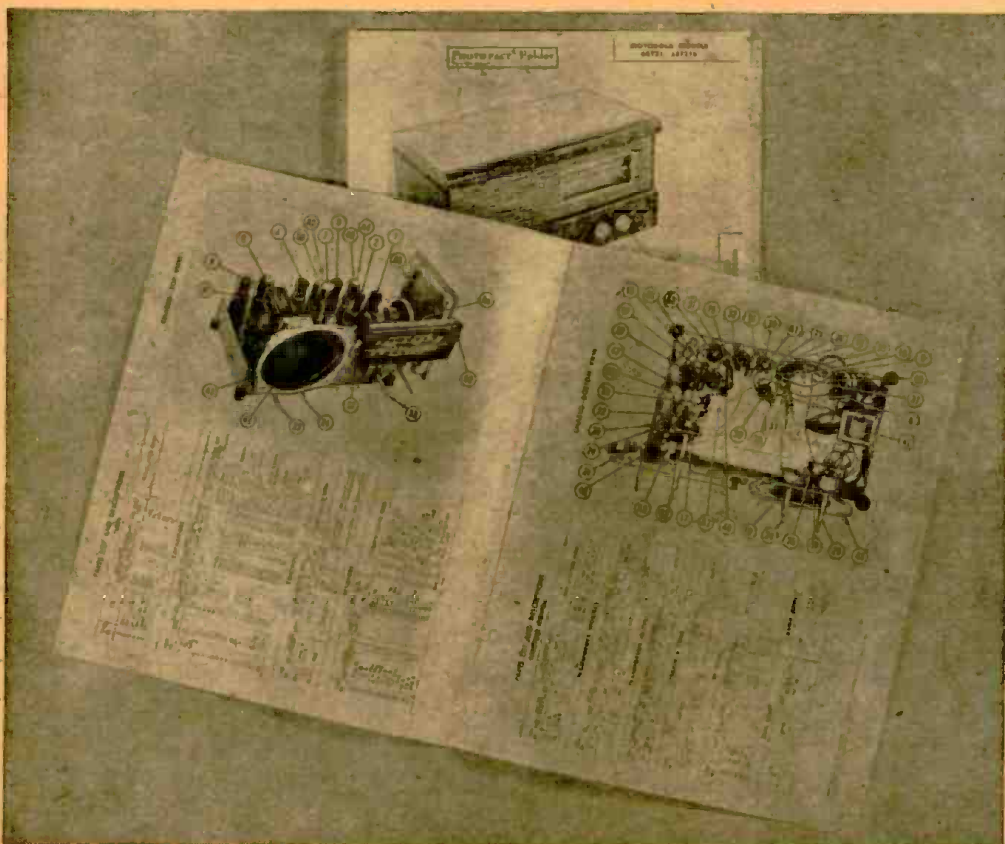

← Folders like this one will be issued on all sets made after Jan. 1, 1946. Each will carry from four to a dozen pages of service information, depending on the set described. These will include standard schematics, plus the photo-aids here illustrated.

# TELEVISION FOR TODAY

## Part III—More on Camera Tubes and Scanning Methods

**T**HE SEARCH for more sensitive television cameras is one of the present major research problems of the television manufacturers.

Toward this end, RCA engineers have recently unveiled a camera tube claimed to be one hundred times more sensitive than the Iconoscope and Image Dissector tubes already described. The tube, shown in Photo A, is known as the Image Orthicon. Due to the additional sensitivity, the tube possesses the following advantages:

1. A greater depth of field, thereby permitting the inclusion of background that would otherwise be obscured or blurred.

2. The ability to televise scenes too dark to produce an acceptable image with the iconoscope and image dissector tubes.

Physically, the tube looks like an elongated image projection tube, being approximately 15 inches long and three inches in diameter at the head. Electrically, the tube is divided into three parts: the image section, where the equivalent distribution of charge over a photosensitive surface is formed; a scanning section, consisting of the electron gun, the scanning beam and deflecting coils; and finally, a multiplier section where, through a process of secondary emission, more current is generated than is contained in the returning beam. This action is closely akin to the electron multiplier contained in the Farnsworth Image Dissector. Fig. 1 illustrates these three sections of the Image Orthicon.

In operation, light rays from the scene to be televised are focused by an optical lens system onto a transparent photo-sensitive plate. At the inner surface of this plate, electrons are emitted from each point in proportion to the incident light intensity. Note that the light rays must first penetrate the transparent plate before they reach the photosensitive inner surface.

The emitted electron image (in which at each point, the density of the electrons corresponds to the light at that point) is accelerated to the target by a positive grid. At the target the impinging electrons produce secondary emission and thus develop a pattern of positive charges directly proportional to the distribution of energy in the arriving electron image. The target is not photosensitive, but it is capable of emitting secondary electrons. Notice that through this method of forming a charge distribution on the target, it is possible to obtain a more intense degree

of positive charge distribution than if light itself had been permitted to shine on a photosensitive mosaic, as in the

to an electron multiplier arrangement where several electrons are produced for each impinging electron. The result

### PRESENT TELEVISION STANDARDS

1. The width of the television broadcast channel shall be six megacycles per second.
2. The visual carrier shall be located 4.5 megacycles lower than the aural center frequency.
3. The aural center frequency shall be located 0.25 megacycles lower than the upper frequency limit of the channel.
4. The visual transmission characteristic shall be: (as shown in Fig. 6).
5. The number of scanning lines per frame period shall be 525, interlaced two to one.
6. The frame frequency shall be 30 per second and the field frequency shall be 60 per second.
7. The aspect ratio of the transmitted television image shall be 4 units horizontally to 3 units vertically.
8. During active scanning intervals, the scene shall be scanned from left to right horizontally and from top to bottom vertically, at uniform velocities.
9. A carrier shall be modulated within a single television channel for both picture and synchronizing signals, the two signals comprising different modulation ranges in amplitude.
10. A decrease in initial light intensity shall cause an increase in radiated power (negative transmission).
11. The black level shall be represented by a definite carrier level, independent of light and shade in the picture.
12. The pedestal level (normal black level) shall be transmitted at 75 percent (with a tolerance of plus or minus 2.5 percent) of the peak carrier amplitude.
13. The maximum white level shall be 15 percent or less of the peak carrier amplitude.
14. The signals radiated shall have horizontal polarization.
15. The radiated power of the aural transmitter not less than 50 percent or more than 150 percent of the peak radiated power of the video transmitter shall be employed.

Iconoscope described in Part II.

The back of the target is scanned by a low-velocity electron beam. This beam is slowed down just short of the plate, and at each point gives up sufficient electrons to neutralize the positive charge at that point. The remainder of the electrons in the beam then return

—at the output—is a current amplified many times over the current in the return beam.

It is evident that the most positive points on the plate return the least number of electrons from the original scanning beam. Hence the voltage developed

(Continued on following page)

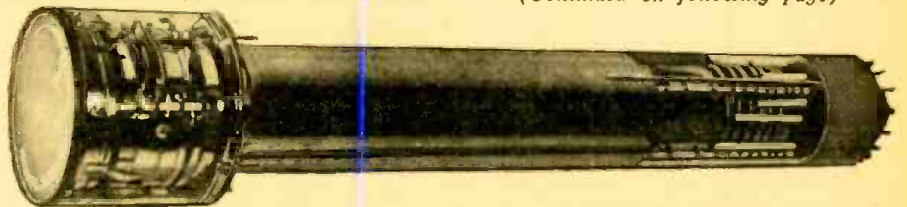
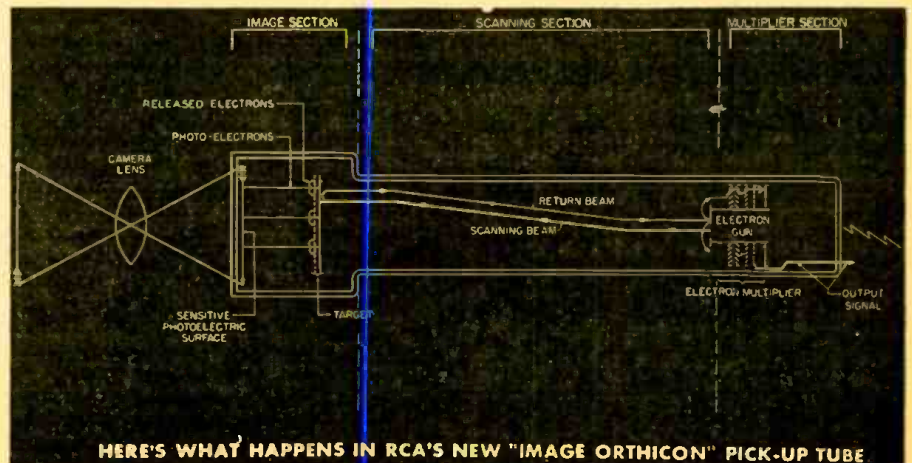

Photo A, above—The Image Orthicon, ultra-sensitive camera tube. Fig. 1, below—Cross-section drawing illustrating its operation.



HERE'S WHAT HAPPENS IN RCA'S NEW "IMAGE ORTHICON" PICK-UP TUBE

across the output load resistor is inversely proportional to the positive charge intensity on the target. As we shall see presently, this corresponds to negative phase polarity in the signal.

### VIDEO POLARITY

Each video signal, shown in Fig. 2, is divided into two fairly distinct regions. From a possible amplitude of 100 percent, 75 to 80 percent is specifically reserved for the camera signal. The remaining 20 to 25 percent is occupied by the blanking and synchronizing voltages.

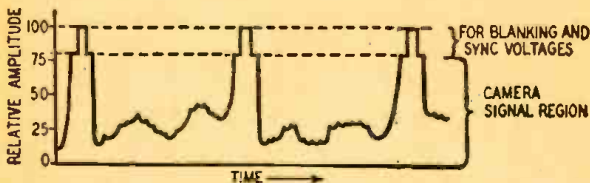

Fig. 2—Negatively-modulated television signal as transmitted.

Within the range allotted to the camera signal, every shade gradation between sheer white and black must be accommodated. Obviously this depends not so much upon the circuit amplifiers as the cathode-ray tube characteristics. If the fluorescent screen is capable of providing a wide contrast range, then each minute voltage variation within the camera signal region will produce varying shades of grey on the screen and the reproduced image will have a rich, full appearance. On the other hand, if the fluorescent screen is sensitive only to relatively large beam changes, the quality will diminish accordingly.

No matter where the camera signal

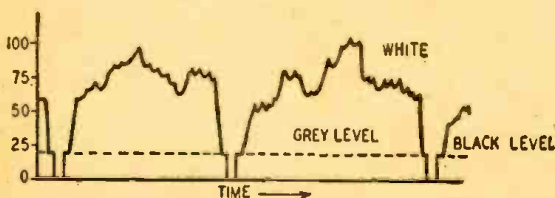

Fig. 3—The signal reversed for application to the viewing tube.

is located at the end of a horizontal line, the voltage always rises to the same level for blanking. This is done purposely, and the blanking of the return trace at the receiver depends specifically upon this fact. In addition, it establishes

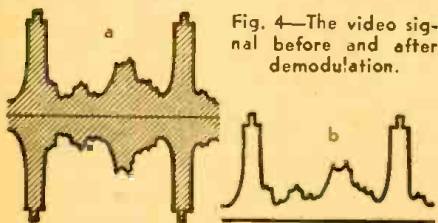

Fig. 4—The video signal before and after demodulation.

a fixed level that varies only with the carrier strength and thus provides a method of obtaining automatic gain control. (More on this later.)

If we attempt to apply the signal voltage, in the form shown in Fig. 2,

to the control grid of a cathode-ray tube, we find that the most positive voltages are those corresponding to the darker shades of grey and black. Obviously this is just the reverse of what it should be, because when the grid is made more positive, more electrons enter the beam and a brighter image is obtained at the screen.

It will be necessary to reverse the entire signal just before it reaches the viewing tube, so the brightest portions assume the most positive polarity and the darkest sections the most negative. This is readily accomplished since passage of any signal through a tube will introduce a phase shift of 180 degrees. The result, after the shift, is shown in Fig. 3.

When the signal is in the form shown in Fig. 2, it is said to be in the negative picture phase. It is this form that has been accepted as standard for transmission in the United States. The signal retains the negative picture phase until after demodulation at the second detector. See Fig. 4. At this point and beyond, in the video amplifiers, the polarity of the video voltage will depend upon the following two factors:

1. The output arrangement of the video detector load resistor, and
2. The number of video amplifiers between detector and cathode-ray tube.

By the time it reaches the control grid of the viewing tube, it must have been reversed to a positive picture phase condition.

In England, the standard for transmission is positive picture phase, as shown in Fig. 3. American engineers claim that our standard results in less interference becoming noticeable on the screen. Their contention is that interference voltages tend to add more frequently to the voltage of the signal than to decrease or oppose it. From Fig. 4-a we can see that an addition of noise voltage would only raise the affected portion of the signal higher into the dark region. Hence, the reproduced image, under interference conditions, possesses a series of small dark spots. With the English system of transmission, the same situation would produce a series of white spots on the screen. The latter would be more annoying.

It is interesting to note that if a receiver designed to operate under U. S. standards receives a signal sent with positive picture phase, the image would be similar to a photographic negative. No matter what transmission system is used, the signal must always be in positive picture phase at the control grid of the viewing tube.

Well known by now is the fact that black-and-white television using 525 lines requires a transmission bandwidth of 6 mc. To learn the reason for this relatively wide band, let us examine the formation of a television signal.

The mosaic of the Iconoscope is composed of many microscopic photosensitive globules. The definition (or the minuteness with which the image is examined) in the vertical direction is 525 lines. Horizontally, the determining factor is the width of the scanning beam. Suppose that the electron beam is so narrow that 400 distinct elements are contained along each horizontal line. Each image, then, is analyzed into 400 elements per line, with 525 lines. Sup-

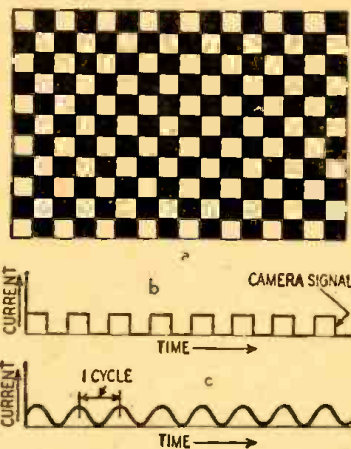

Fig. 5—Picture elements related to bandwidth.

pose further, that every other element is white, producing the effect shown in Fig. 5-a.

When we scan such a mosaic, the output voltage, along some line, will be as indicated in Fig. 5-b. The similarity of this voltage with a sine wave possessing the same fundamental frequency. Fig. 5-c, is evident by inspection. Hence, in this particular case, scanning of the 400 elements will produce an output wave with a fundamental frequency of 200 cycles. Each black and white dot form one cycle. Since 525 lines are

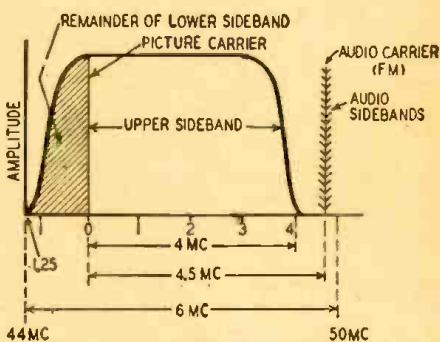

Fig. 6—Lower sideband is partly suppressed.

scanned in 1/30 of a second, or 15,750 lines in one complete second, 200 cycles per line will give an output frequency of  $15,750 \times 200 = 3.15 \text{ mc}$

In actual practice a bandwidth of 4 mc is allowed. Admittedly the foregoing situation is never found in practice, where variations from one point to another do not occur so abruptly. However, the analysis does produce satisfactory results and is, in this respect, justified.

When we amplitude-modulate a carrier, we produce sidebands above and below the carrier frequency. Thus, employing the above figures, the television (Continued on page 777)

# WAVE SHAPING CIRCUITS

## How and Why Wave and Pulse Forming Equipment Operates

AS THE development of television, radar and the electronic control of industrial processes continues, there is an increasing interest in voltage and current wave shapes. Formation of special purpose wave shapes from the conventional sinusoid produced by alternating current generators and oscillators is a special and important problem. This paper analyzes several simple shaping circuits using diodes and triodes which modify sinusoids into square waves.

A typical circuit employing a duo-diode is illustrated in Fig. 1-a. As long as the instantaneous voltage of the sinusoidal input is less than the voltage on the cathode of tube section T1 ( $E_k$ ) and more than the voltage on the plate of tube section T2 ( $E_p$ ), no current flows in the circuit since neither tube section conducts. Thus the output voltage B to C will be exactly the input voltage, and the voltage A to B will be zero. The resultant of this condition in the three voltage waveforms under consideration is illustrated in Fig. 1-c in the periods from 0 to 1, from 2 to 3, from 4 to 5 and from 6 to 7.

When the input voltage rises above  $E_k$ , the tube section T1 conducts and tube section T2 remains non-conducting. While this condition exists the tube may be represented by the equivalent circuit

Fig. 1-b by the dynamic plate resistance  $\delta$  (effective plate voltage)

$$r_{p1} = \frac{\delta}{\delta \text{ (plate current)}}$$

If  $r_{p1}$  is very much less in magnitude than the plate resistance,  $R_L$ , most of the instantaneous voltage rise above  $E_k$  will appear across  $R_L$ , A to B, and the output B to C across  $r_{p1}$  will remain at about  $E_k$ .

Consider the following numerical example:  $R_L = 1$  megohm,  $r_{p1} = 1000$  ohms, then Voltage B to C =  $(E_k - E_k) \frac{1}{1001}$ . Thus the output voltage B

to C, will increase above  $E_k$  only one thousandth of the rise of the input voltage above this value, producing fairly neat clipping at this level. This condition appears in the voltage waveforms in periods from 1 to 2, and from 5 to 6, Fig. 1-c, center.

The whole process goes into effect with tube section T2 when the instantaneous input voltage falls below  $E_p$ , causing T2 to conduct while T1 remains cut off. Since the dynamic plate resistance of this section is the same as the first section, the output voltage swing in the negative direction is limited to the value of  $E_p$ .

The amplitude of the square wave may be controlled by the magnitude of voltages  $E_k$  and  $E_p$ . The ratio between the amplitude of the input sinusoidal voltage and the magnitude of  $E_k$  and  $E_p$  respectively affects the steepness of the sides of the resultant square wave.

The triode wave shaper depends for its operation upon (1) distortion of the effective grid voltage and the magnitude of  $E_k$  and  $E_p$  respectively affects the steepness of the sides of the resultant square wave. (2) upon the sharp cutoff of plate current when the effective grid voltage decrease to and beyond the cutoff voltage of the tube.

The triode wave shaper under consideration is shown in Fig. 2-a. The plate characteristics of the tube are such that the relationship between the effective grid voltage and the plate current is linear from grid cutoff to zero (Fig. 2-c, effective voltage). Consequently, the output voltage in this phase of operation will be the same shape as the input voltage but amplified and 180° out of phase. See periods from 2 to 3, from 4 to 5 and from 6 to 7 in Fig. 2-c representing the voltage and current waveforms of interest.

When the instantaneous input signal increases above the cathode bias voltage

$E_k$  and the effective grid voltage is positive, grid current flows between grid and cathode. For analytical purposes the part of the input circuit between grid and cathode can be replaced by the dynamic grid resistance,

$$r_g = \frac{\delta \text{ (effective grid voltage)}}{\delta \text{ (grid current)}}$$

as in the equivalent circuit Figure 2-b.

In this circuit the voltage drop across  $r_g$  due to grid current flow is the effective grid voltage. If the grid resistor  $R_g$  is very much greater than the dynamic grid resistance  $r_g$ , most of the instantaneous voltage rise above  $E_k$  will appear across the grid resistor and very little across the dynamic grid resistance so that the rise of the effective grid voltage above zero will be very slight. A numerical illustration follows: If  $r_g = 10,000$  ohms and grid resistor  $R_g = 1$  megohm, then—Effective Grid Voltage = (Instantaneous Input Voltage — Cathode Voltage) 1/100

In this case the effective grid voltage will only rise above zero a hundredth (Continued on page 793)

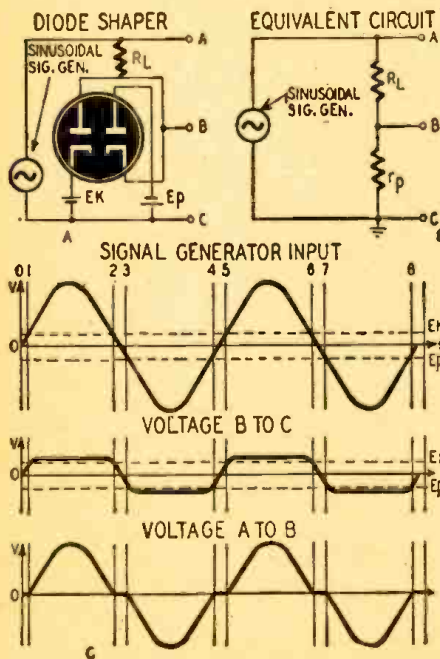
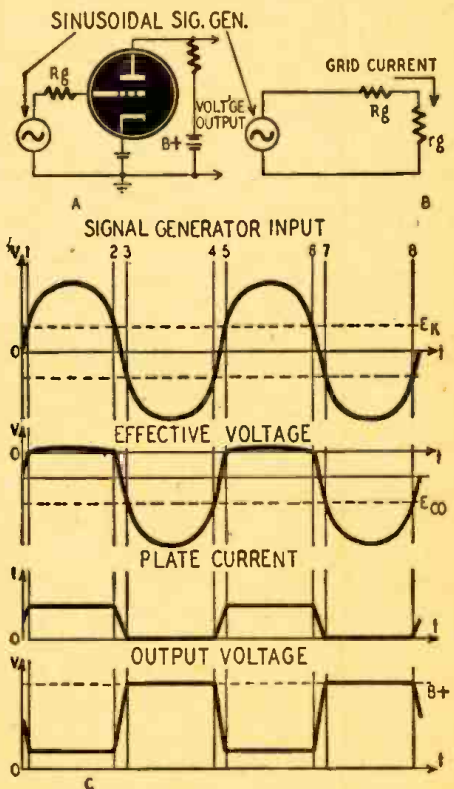

Fig. 1-a—Typical duo-diode shaping circuit. 1-b—An equivalent circuit of the duo-diode. 1-c—Waveforms, as described in text above.



Figs. 2-a and b—A triode wave shaper and equivalent circuit. 2-c—Waveforms as produced by the triode waveform shaping unit.

# RADIO DATA SHEET 338

## GENERAL ELECTRIC MODEL No. 250

### SPECIFICATIONS

#### Electrical Rating:

Connected to Power Line:  
105-125 v., 50/60 cps, a-c only, 10 watts.

#### Operating from Internal Battery:

2.1 v., 1.65 a., 3.5 watts.  
Receiver will operate approximately 20 hours before battery must be recharged.

#### Operating Frequencies:

Broadcast Band ..... 540-1600 kc  
I-F Amplifier ..... 455 kc

#### Tube Complement:

R-F Amplifier ..... 1LN5  
Oscillator-Converter ..... 1LC6  
I-F Amplifier ..... 1LN5  
Detector and Audio Amplifier ..... 1LH4  
Power Output ..... 3Q5GT

- The following equipment is required: (a) signal generator with audio tone modulation, (b) a-c output meter, 1 or 1/2 volts full scale, and (c) an insulated screwdriver.
- Remove the front panel from the receiver and connect the output meter across the speaker voice coil terminals. Replace the front cover after the meter has been connected.
- Alignment Steps 1 and 2. Connect the signal generator between chassis ground and stator of C2-A (middle section of tuning gang), using a 0.05 mf capacitor in series with the lead to the stator.
- Alignment Steps 3 and 4. Connect a three- or four-turn, 6-inch diameter loop of wire across the output of the signal generator. Set the loop a foot or two away from the receiver cover.

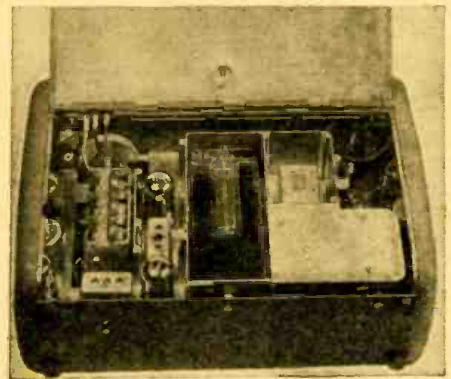

- When aligning, the output of the signal generator should be kept below 1/2 volt by resetting the signal generator output. If the signal level is too high, the AVC becomes effective and alignment errors may result.

### ALIGNMENT CHART

Turn Tone Control CCW (Treble)  
Turn Volume Control CW (Maximum)

STEP	CONNECT SIGNAL GENERATOR TO	SIGNAL GEN. SETTING	DIAL SETTING	ADJUST
1	Stator of C2-A in series with 0.05 mf.	455 kc	Reference Point Below 550 KC (Gang Closed)	2nd i-f (T-2) Trimmers for Max.
2	Stator of C2-A in series with 0.05 mf.	455 kc	Reference Point Below 550 KC (Gang Closed)	1st i-f (T-1) Trimmers for Max.
3	*Inductively Coupled	580 kc	580 kc	**L3 and L4 for Max.
4	*Inductively Coupled	1500 kc	1500 kc	***C3-B, C2-B, and C1-B for maximum in sequence given.

### ALIGNMENT PROCEDURE

- Complete alignment information is given in the Alignment Chart.



- \*Use loop on output of signal generator.
- \*\*Adjust L3 and L4 alternately several times to obtain peak.
- \*\*\*Remove snap buttons in back to permit these adjustments. Keep back cover closed while aligning.

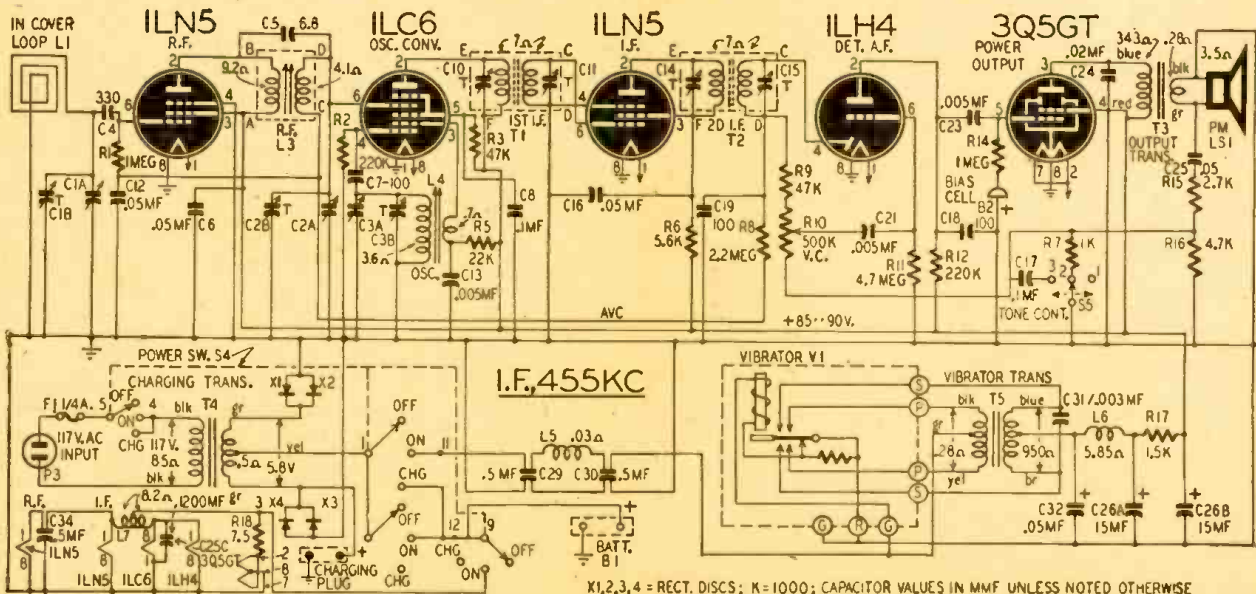



# TONE CONTROL CIRCUITS

## Simple Resistance-Capacity Tone Compensation Networks

**B**ECAUSE of the expense, physical size and sharper resonant peaks, inductance-capacitance types of tone control circuits are often impractical or otherwise undesirable. Here are five inexpensive, physically small and broadly resonant resistance-capacitance tone control circuits.

Circuit 1 provides fixed bass reinforcement through the series parallel arrangement R1, R2, and C1. Condenser

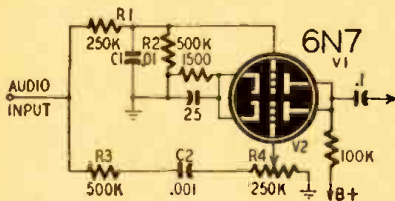

Fig. 1—A simple resistance-capacity circuit.

C1 offers very low reactance to the higher audio frequencies, thus attenuating the treble notes, and offers high reactance to the lower audio frequencies, permitting the bass notes to pass through to the grid of the bass amplifier tube, V1. C2 and R3 form a series circuit which offers higher reactance to the bass frequencies than it does to the treble, thus permitting the high notes to pass through to the grid of the treble amplifier tube, V2. R4 is an ordinary gain control, and by varying the signal input to the treble amplifier and keeping the bass amplifier at a constant level, the effect is that of a true tone control,

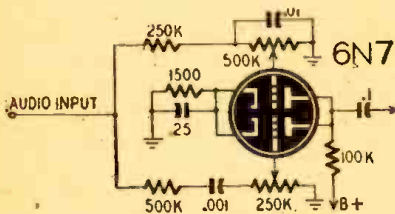

Fig. 2—Treble and bass control are variable.

giving full bass response at all times. There is no audible interaction between the two tubes, V1 and V2. In the experimental circuit a 6N7 dual-triode tube was used. V1 is the upper and V2 the lower half of the tube in Fig. 1.

Circuit 2 is similar to Circuit 1, with the addition of a gain control in the grid of the bass amplifier. This makes for a more flexible equalization of tone. It is particularly recommended for use in recording amplifiers where varied equalization problems are encountered. With this circuit, the fidelity response peculiarities of cutting heads, play-

back pickups, amplifiers and loud speakers can be compensated for. Using this arrangement in a recording amplifier with a cheaper cutting head, the results as judged by "good ears" were all that one could desire. Again, a 6N7 and the part values shown were used.

Circuit 3 is another arrangement of dual tone controls (bass-treble) using a single triode instead of a dual triode and mixing the bass and the treble in the same grid. The gain in this circuit is appreciably less than that of the previous tone controls, due to the 500,000 ohm series resistors (R5, R6) in the arms of the potentiometers (R3, R4). These resistors decouple the two potentiometers in order to limit their interaction to an inaudible degree. A single 6C5 triode and the part values given were used in the finished model.

Circuit 4 combines the features of the

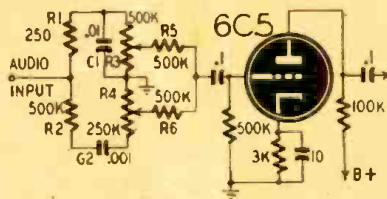

Fig. 3—Duo-control circuit with triode tube.

three previous circuits. The condenser C1 goes to the variable arm of the potentiometer R2 and, as the potentiometer is rotated from the grid side to the ground side, the tone response is varied from treble to bass. With the condenser at the grid side, the bass notes are attenuated due to high reactance of C1 and resistance of R1. With the condenser at the ground side of R2, high notes are bypassed due to the low reactance of C1 at higher frequencies. Intermediate positions of R2 give varying response and fidelity characteristics to suit the ear of the listener. A 6C5 triode and the part values shown were used in the model.

Circuit 5 is the familiar tone control used in most home receivers and many public address systems. As R1 is varied, bringing C1 closer to ground, greater attenuation of the higher frequencies occurs, making the response more bass, or less treble. The disadvantage is that no bass accentuation, reinforcement, or compensation is provided for. Its simplicity of installation and comparatively low cost make it quite popular.

All of these circuits cause some loss in gain. This is caused by the resistors necessary to decouple the separate bass

and treble mixers. However, the results achieved by these simple arrangements for controlling tone more than compensate for the lost gain.

The reason for the losses in gain be-

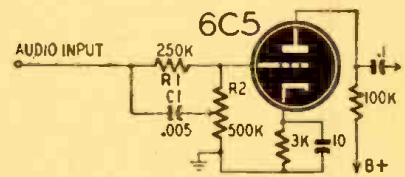

Fig. 4—Simplest type of duo-control circuit.

come more apparent when considering R1 and R2 and their arrangement in Circuit 1. Resistors R1 and R2 in series are in effect a voltage divider, and when a signal voltage appears across the input, a voltage drop appears across R1 and R2. This voltage drop can be computed by this simple formula and a little elementary algebra.

$$E_{grid} = \frac{R_c \times E_{input}}{R_{total}}$$

For example, Fig. 6. If we consider a phonograph pick-up having a voltage output of .85 volts and connect it to points (a) and (c), what voltage will appear at the grid of the tube, points (b) and (c)?

$$(1) E_{grid} = \frac{R_c \times E_{input}}{R_{total}}$$

$$(2) E_{grid} = \frac{500,000 \times .85}{750,000} = 0.566 \text{ volt}$$

Note that in some of these circuits tube grids are connected directly to the

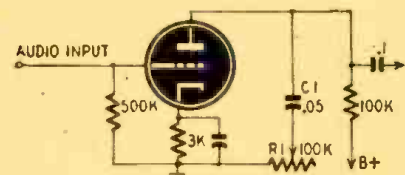

Fig. 5—The old treble-cutting "tone control."

audio input, without a series condenser. In these circuits, no d.c. may be applied from the preceding stage. Where the control connects to the secondary of a transformer, as in certain audio and magnetic pickup circuits, no precautions need be taken. When connected to a crystal pickup, a resistor of at least one-half megohm should be bridged between input and ground. If operated

(Continued on page 781)

# CHECK LIST FOR REPAIRMEN

## An Aid to Systematic and Thorough Servicing Procedure

A LARGE number of men who learned radio and electronics in the Army, Navy, and Marine Corps are returning to civilian life with a desire to go into the radio repair business. Many of these veterans will open shops of their own. A *check list* will be an aid to these well-trained newcomers of the business as they go about repairing those all-important first few radios. This chart may also be of some help to other servicemen who have felt a need for a systematic, thorough procedure to be followed, but just "never got around to it."

This check list is not a ten-minute course in radio repairing. Previous training and experience are required to perform each step mentioned in the list. The items are listed as a reminder to the trained man of the necessary steps that must be taken to properly service a customer's inoperative radio.

A detailed explanation of each item in the check list is presented in the text of this article. The check list may be clipped out, pasted to a piece of cardboard, and located in a conspicuous place above the service bench. If this card is tacked to the vertical part of the work bench at eye level, the repairman is able to refer to it merely glancing up from his work. Strategically located, this check list is a constant re-

minder that an orderly, thorough repair job is a satisfaction in itself and pays off in the form of added profits.

CHECK LIST	
1	VISUAL INSPECTION
2	TUBE CHECK
3	VOLTAGE MEASUREMENT
4	SIGNAL TRACING
5	REPAIR
6	TEST ALL CONTROLS
7	VIBRATION TEST
8	SENSITIVITY CHECK
9	ALIGNMENT
10	TWO HOUR CHECK

### 1. VISUAL INSPECTION

a—Carefully inspect for defective a.c. cord and plug, fuse, and pilot light.

b—Look over the antenna, speaker, and ground connections.

c—The tubes also warrant a good visual check. You may find tubes loose in their sockets, or even cracked or broken glass envelopes.

d—On the upper side of the chassis, look for loose grid cap clips, broken wires, shorted tuning condenser, and broken or slipping dial drive belt.

e—On the under side look for charred resistors or condensers, shorts, broken wires, defective power switch, tar from power transformer, excessive melting of filler in the condensers, and poor soldered joints. Rosin core solder was a scarce commodity during the war and many servicemen were forced to use other fluxes. You may find poor joints due to this cause for some time.

### 2. TUBE CHECK

a—Two things must be kept in mind when testing tubes:

1—A serviceman is never wasting time in *carefully* testing the tubes in a nonoperative receiver.

2—Few, if any, tube testers have a conclusive test for a gassy tube. Watch for tubes that seem to have a mutual conductance above rated value, or those whose emission is above that given on the chart of the tube tester—they may be gassy.

b—If the radio is one of the popular a.c.-d.c. models and the filaments do not light, check *all* tubes.

c—If the rectifier, 35Z3, 35Z5, 25Z5, etc., is bad, check the high voltage filter condenser in the set before turning on the power with a new tube in the socket.

d—If the radio has a power transformer, and one or more of the tubes do not light, check these first, but *test all tubes*.

### 3. VOLTAGE MEASUREMENT

a—Voltage measurements should be taken with the best voltmeter available. Many radio circuits have very high impedance and a voltage measurement is practically meaningless unless taken with a voltmeter whose sensitivity is 1000 ohms per volt or better. A *vacuum-tube voltmeter is highly recommended*.

b—Measure the B supply voltage on each side of the filter. In an a.c.-d.c. set this should be about 90 volts on the filtered side, and about 115 volts on the cathode of the rectifier tube. In sets powered by a transformer the B voltage will vary from 200 to 400.

c—Measure the plate voltage of each amplifier tube. All tubes except the resistance coupled audio stages and the second detector diode should have a

(Continued on page 788)

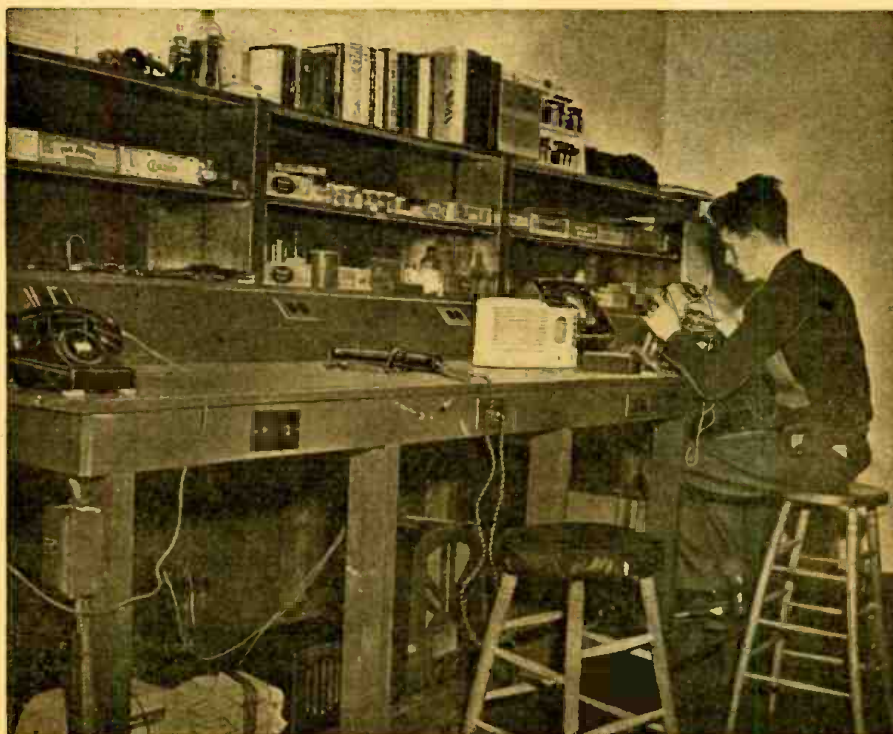

Systematic service bench of Shelton Powell, Watertown, New York. Ample storage space for spare parts on shelves and telephone at end of bench indicate time-saving and efficiency.

# TRANSATLANTIC NEWS

*From our European Correspondent, Major Ralph Hallows*

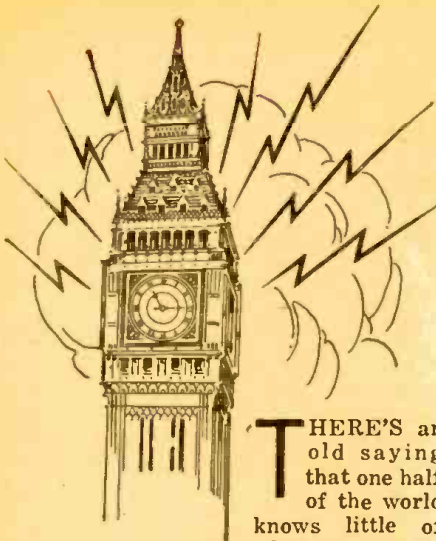

**T**HERE'S an old saying that one half of the world knows little of what goes on in the other half. Well, so far as radio is concerned, I hope to keep you informed month by month of what is being done across the Atlantic in Britain and the rest of Europe. The start of a new feature is always a somewhat nerve-racking experience for its writer, no matter how often he has previously committed authorship. He does not yet know his readers and he feels rather like a stranger butting in on a party of friends.

But, now that I come to think of it, I probably do know some of you. During the war I was in radar and it was my privilege to have working with me quite a few American hams. They formed a kind of advance guard for the U. S. Army, for they came over not so long after Pearl Harbor to help us out when we were desperately short of technical men. The use of radar was expanding so rapidly at that time that we just could not keep pace with the demands for men with a background of radio and general electricity to supervise the servicing of the equipment and its maintenance in first-class working order. The steady stream of American volunteers filled the gap, doing in a few months several years of normal peacetime work.

## MAN-MADE STATIC

A government-appointed committee has been appointed to go into the question of man-made radio interference and to make recommendations for its abatement. It is expected to define radio interference as stray radiation (from any device) sufficient to spoil reception of a radio signal of strength not less than one millivolt. This will have to apply not only to the "medium" 1500-500 kc band, but also to the important European 300-150 kc and the 40-mc bands. Recommendations will presumably apply to domestic electric apparatus and automobile ignition systems.

## BIG BETATRONS

What are believed to be the world's most powerful betatrons are now under construction in this country. The first, rated at 200 million electron volts, is to

be erected at Glasgow, where Professor Dee is in charge of nuclear physics research. The magnet of this giant weighs 130 tons, but it is a midget compared with that of the monster betatron to be installed at Birmingham University. This will have a rating of 1,000 million electron volts, or ten times that of any betatron now in existence. This giant will be under the charge of Professor Oliphant, who was a member of the British atomic team in the United States during the war. I can't help wondering what sort of a time radio DX fans living close to a super-betatron are going to have.

## HI-FI TAPE RECORDING

There seems little doubt that the Magnetophon, a magnetic tape recorder perfected during the war and since the war by the Germans, presents the greatest advance yet made in genuinely high quality recording. Two of its outstanding qualities are the almost entire absence of surface noise and its remarkable frequency range from 25 to 10,000 cycles.

Noise reduction is brought about largely by the use of a supersonic oscillator (40 kc) in connection with the erasing head. Supersonic excitation at a frequency of 100 kc is used also in the recording head. The thin plastic

tape, impregnated with ferric oxide dust, weighs about one-fourth as much as steel tape, and is made up on 1,000-meter reels. As the tape speed is a little over 45 meters per minute, each reel records or plays back approximately 22 minutes.

## DX ON FM BANDS

Freak reception on the short and ultra-short waves has been frequent of late owing to disturbed conditions in the ionosphere. It will be of great interest to know whether any radio fan in the United States succeeds in picking up the experimental FM transmissions which the BBC is now making between 6 and 8 pm, GMT, each evening, or 1 pm and 3 pm, EST. The frequency used is in the neighborhood of 90 mc and the normal limit of reception should be 30 to 50 miles from London. But all the rules laid down in the text books about u.h.f. transmissions can be upset during ionospheric disturbances. If you remember, our 40-mc television transmissions were often received in New York and in South Africa in 1939. During that year I more than once picked up snatches of messages transmitted on u.h.f. by American police. If any reader does succeed in hearing our FM will he please let me know? Send particulars of

*(Continued on page 808)*

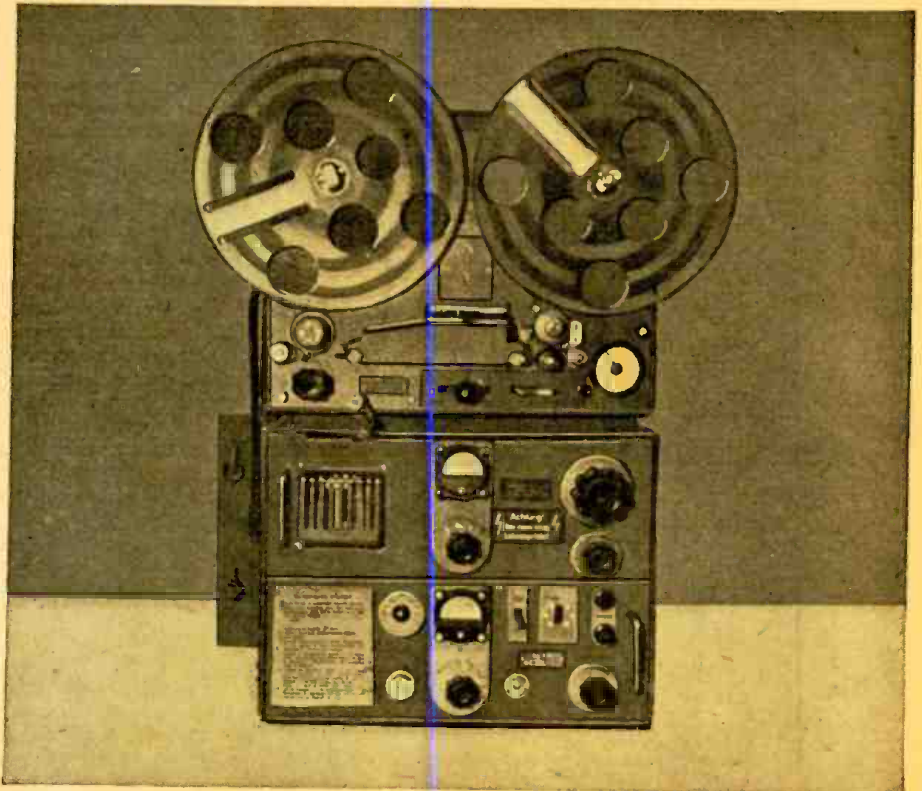

The German Magnetophon described above is a larger device than American tape recorders.

# WORLD-WIDE STATION LIST

**N**EW dope on the short-wave bands seems to be at an all-time minimum this month, and very little activity seems to be in the offing for the balance of the summer months. Conditions have been fair, but nothing in the way of dx has been reported. Reports this month were received from Bill Howe of Alexandria, Virginia; Gilbert Harris of North Adams, Massachusetts; Bruce DeHond of Rochester, New York; the Canadian Broadcasting Corporation; the Australian News Agency; the British Broadcasting Corporation, and Martin

Harrison of Victoria, Canada, who sent his report this month from Darlington, England, where he is stationed.

A short time ago we were approached with the idea of starting a Short Wave League with an active membership, and some space devoted to it in each issue. We would like to get your ideas on this matter. Due to the present paper situation it would not be possible to have any space in the magazine, but this could be taken care of by other means for the time being. One method would be by mimeographed letters and reports. Let us hear of what you think

about the matter, and also any suggestions which you have for its type of organization, scope of work, and results expected.

By next month, the fall schedules will begin shaping themselves, and some revisions should be ready for publication. In the meantime, see what you can find on the short wave bands, and then let us know what you have heard. Send all reports and inquiries to Shortwave Editor, c/o RADIO-CRAFT, 25 West Broadway, New York City 7.

All schedules are in Eastern Standard Time.

Location	Station	Frequency and Schedule	Location	Station	Frequency and Schedule	Location	Station	Frequency and Schedule
ALASKA	WXFD	12.250 8 pm to midnight				BELGIUM		to 12:15 pm
ALBANIA	ZAA	7.950 English at 3 to 3:20 pm				Brussels	11.845	evenings about 7:30 pm
ALGIERS			Melbourne	VLG10 11.760	1 to 1:40 am; British beam; 1:55 to 2:25 am; North Asiatic beam; 2:30 to 2:55 am	Brussels	11.765	5:30 to 6 pm; 8 to 8:15 pm
ALGERIA		8.040 12:30 to 6 pm	Melbourne	VLA4 11.710	3:55 to 5:15 am	Brussels	17.836	6 to 7 am; 11 am to noon
ANDORRA		11.765 8 am to noon	Shepparton	VLG7 11.840	North American beam; 12:10 to 12:40 am	BOLIVIA		
		9.330 noon to 7 pm				La Paz	CP5 6.205	5:15 to 9:45 pm
		5.897 5 am to 7 pm	Melbourne	VLG4 11.840	Tahiti beam, 1 to 1:40 am	Cochabamba	CP40 6.510	7:30 to 10 pm
ANGOLA						La Paz	CP49 6.770	7 to 9 pm; 11 am to noon; 6:30 to 9 pm
Benguela	CR6RB	9.165 3:30 to 4:30 pm; 8:30 to 9 pm				BORNEO		
Louanda	CR6RA	9.470 heard signing off at 3:30 pm				Balkpapan	9.120	5 to 6 pm
ARGENTINA						BRAZIL		
Buenos Aires	LRS1 6.985	7 to 10 pm				Belém	PRCS 4.865	5 to 7 pm; 8 to 9 pm
Buenos Aires	LRY1 6.060	5:45 to 7:15 am; 5 to 9 pm	Melbourne	VLA6 15.200	Japanese beam, 2:30 to 3:30 am	Sao Paulo	ZVB7 6.095	4:30 to 10 pm
Mendoza	LRM 6.180	5:15 to 10 pm	Melbourne	VLG6 15.230	North Australian beam; 10 to 10:25 pm	Fortaleza	PRE9 6.105	3:30 to 6:15 pm Mondays; 3:30 to 8:35 pm other days
Buenos Aires	LRA1 9.683	6 to 8:30 pm	Shepparton	VLG4 15.315	North American beam; 5:45 to 9:45; 12:10 to 12:45 am; Asiatic beam; 5:30 to 6 pm; Philippine beam; 7 to 7:15 pm; North Australian beam; 10 to 10:25 pm	Maceio	9.300	6 to 7 pm
Rosario	LRR 11.880	heard at 7:30 pm				Rio de Janeiro	ZYC6 9.810	evenings till midnight
Buenos Aires	LSN3 12.190	6:15 pm	AUSTRIA			Rio de Janeiro	PRL7 9.720	3 to 9:30 pm
Buenos Aires	LSL3 15.810	heard mornings	Vienna	7.140	midnight to 2 am; 6 to 8 am; 10 am to 4:30 pm	Rio de Janeiro	PSH 10.220	evenings
AUSTRALIA			Vienna	7.160	midnight to 2 am; 6 to 8 am; 10 am to 8:30 pm	Rio de Janeiro	PRL8 11.720	9:30 to 9:55 pm; off Saturdays and Sundays
Brisbane	VLQ2 7.215	2:30 to 8:30 am	Vienna	9.823	midnight to 2 am; 6 to 8 am; 10 am to 4:30 pm		PST 12.080	6 to 7 pm
Melbourne	VLA 7.280	7:45 to 10 am; 10:15 to 10:45 am	Vienna	12.210	afternoons at 4:30 pm	BRITISH GUIANA		
Perth	VLW7 9.520	5:30 to 10:30 am				Georgetown	ZFY 6.000	5:45 to 7:45 am; 9:46 to 11:45 am; 2:15 to 7:15 pm
Melbourne	VLG2 9.540	Asiatic beam; 7 to 9 am	AZORES					
Shepparton	VLG5 9.540	North American beam; 7 to 7:45 am; 8:45 to 9:45 pm	Ponta del Gada	4.040	4 to 6 pm	BRITISH WEST INDIES		
Melbourne	VLG 9.580	Indian beam; 9:35 to 9:45 am	Ponta del Gada	11.090	3 to 4 pm	Jamaica	VRR4 11.595	heard at 10 am
Shepparton	VLG6 9.615	North American beam; 10 to 10:45 am; Philippine beam; 4 to 5 am; Asiatic beam; 5:15 to 6:45 am; 8 to 9:15 am; Indian beam; 9:35 to 9:45 am	BAHAMAS			VRR5 15.620		
			Nassau	ZNS4 6.090	7:45 to 8:30 am; 11:30 am to 1:30 pm; 4 to 10 pm	BULGARIA		
Shepparton	VLG2 9.680	North Asiatic beam; 2:30 to 3:30 am; British beam; 11:15 to 11:45 am	BELGIAN CONGO			Sofia	9.350	on at 11 pm
Sydney	VLN 10.420	around 12:15 am	Leopoldville	OTC 9.385	5:30 to 7:30 am	BURMA		
Melbourne	VLG3 11.710	North American beam; 10 to 10:45 am; 8:45 to 9:45 pm; Tahiti beam.	Leopoldville	OTC 9.745	relays BBC at 8:30 to 11:45 pm	Rangoon	11.860	10 pm to 1 am; 2:15 to 3 am; 8:30 to 10 am
			Leopoldville	OTC 11.720	5:30 to 7:30 am	CANADA		
			Leopoldville	OTC 17.770	6 to 9:30 am; 11:30 am	Edmonton	VEBA1 6.005	midnight to 2 am

## RADIO TERM ILLUSTRATED

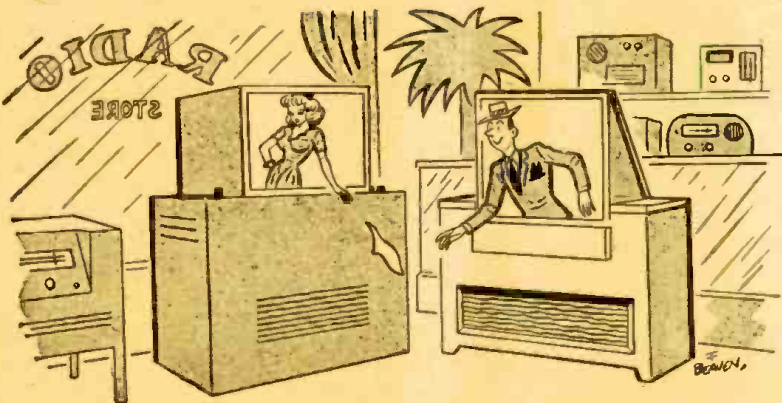

A television pickup.

CEYLON			Colombo	ZOJ 11.810	5 am to noon
			Colombo	ZOJ 15.275	news at 10 pm and midnight
CHILE			Santiago	CEI174 11.740	7 am to 11:30 pm
			Santiago	CEI180 12.000	late afternoons
CHINA			Chungking	XGOY 7.153	6:30 to 10:30 am
			Chungking	XGOY 9.646	East Asia and South Seas beam; 6:35 to 8:40 am; North American beam; 8:45 to 10:40 am; European beam; 10:45 to 11:30 am; East Asia and South Seas beam; 11:30 am to 12:45 pm
			Chungking	XGOA 9.730	11:30 pm to 12:45 am; 4:20 to 7:15 am
			Chungking	XGOY 11.900	Allied Forces in Far East beam; 7 to 8 pm; Asia - Australia - New Zealand beam; 5 to 5:30 am; East Russia beam; 5:30 to 6 am; Japan beam; 6 to 6:30 am

(Continued on page 801)

?? WHY NOT ??

Have you ever asked yourself, "Why can't I have this or that gadget on a radio? Why aren't programs made to fill such and such a need?" If so, you are a charter member of the *Radio-Craft* "Why Not" club. Send us your "Why Not's" on all subjects—serious or screwball, practical or idealistic. We will pay \$1.00 for every one we believe will interest the readers of *Radio-Craft*.

You can get the idea from the "Why Not's" printed below. Send in as many as you like. One dollar will be paid for each one printed.

Why not have the manufacturers put luminous numbers on the dial face of receivers to eliminate the need for dial lights?

HARRY KELLERMAN,  
Scranton, Pa.

(The suggestion is good, but by no means new. It has been suggested many times. See also *RADIO-CRAFT* February, 1945 issue. In the 30's several mail-order houses were selling luminous dials, which the radio set user could put on his radio. If there should be enough demand for this, radio manufacturers will probably adopt it.

The main objection is that few people use a radio set in total darkness, where the luminous numbers would be of advantage. In a dim light or with some light in the room *without* a dial light, the numbers could not be seen. This must be kept in mind.—*Editor*)

Why not restrict tube manufacturers from putting new tubes on the market which are identical in characteristics to those already in use except for tube base connections? A good example is a comparison of the 5Y3 and 5Y4 rectifier tubes. This practice forces the radio serviceman to invest a large amount of capital in tubes with identical electrical characteristics.

CPL. RICHARD R. HILLIS,  
Luzon, P. I.

Why not have all radio manufacturers calibrate their tuning dials more accurately and completely than they have been doing in the past? They have refrained from putting more dial markings on the set because it detracts from the "ultra modern" appearance of the set. An accurately calibrated dial is a necessity to ardent DX'ers and short wave fans.

ROBERT E. NISSLEY,  
Camp Hill, Penna.

Why not have television receivers equipped with push buttons that would operate relays which would tune the antenna to the desired frequency, thus eliminating "ghosts"?

J. B. SHAW, JR.,  
Augusta, Maine

(The above idea is, of course, practical from a technical standpoint, but from an economic viewpoint it would increase the cost to an extent that might make it unattractive to the average television set user.—*Editor*)

New! Complete!  
**CONCORD**  
Radio  
Catalog

FREE



NEW RADIO SETS

NEW AMPLIFIERS

NEW RADIO PARTS

Electronic Equipment

HAM GEAR

**STANDARD LINES! LARGEST STOCK!  
IMMEDIATE SHIPMENT!**

For the newest, the latest, and the best in radio sets, radio parts, amateur kits, and test equipment, mail coupon below for your free copy of Concord's first post-war Catalog. It offers a huge storehouse of everything that's new in radio and electronics . . . including the sensational, talked-about line of exclusive Concord Multiamp ADD-A-UNIT amplifiers. It contains thousands of items . . . all standard lines . . . war-born discoveries and improvements . . . all ready for same-day shipment direct to you from CHICAGO or ATLANTA.

**History-Making ADD-A-UNIT Line of Amplifiers**

Typical of Concord leadership is the completely revolutionary line of Multiamp ADD-A-UNIT Amplifiers, designed and engineered by Concord, sold only by Concord. Built on entirely new principles, these Amplifiers offer startling innovations not available elsewhere . . . new high standards of flexibility, fidelity, power, economy, and all-round performance almost beyond belief. Mail coupon now for Concord's New Complete Catalog showing full amplifier line . . . and complete assortments of "everything that's new in radio and electronics."

**CONCORD**  
RADIO CORPORATION  
LAFAYETTE RADIO CORPORATION  
CHICAGO 7 ATLANTA 3  
901 W. Jackson Blvd. 265 Peachtree Street

CONCORD RADIO CORPORATION  
901 W. Jackson Blvd., Dpt. RC-86, Chicago 7, Ill.  
Yes, rush FREE COPY of the comprehensive new Concord Radio Catalog.

Name.....  
Address.....  
City..... State.....

# New

# RADIO-ELECTRONIC DEVICES

## AUDIO AMPLIFIER

Amplifier Co. of America  
New York, N. Y.

The Model ACA-100DC amplifier is direct-coupled amplifier designed to pass a wide band of frequencies with low distortion. It is particularly useful in making sound measurements and for reproduction of AM and FM radio programs.

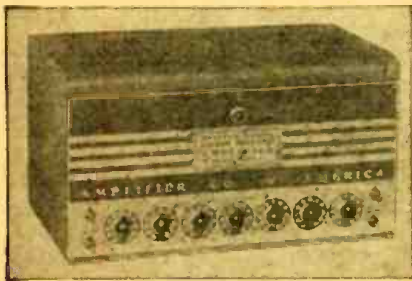

It develops 23 watts of audio power with less than 1 percent total distortion and 12 watts with less than 1/2 of 1 percent. Response is flat within plus or minus 1 db from 20 to 20,000 cycles. Thirteen tubes are used in the unit, which includes a voltage-regulated power supply. Two 500,000-ohm input channels are provided. The output transformer is designed to work into 15 different load impedances between 1 and 500 ohms.

Other features of the amplifier are: non-frequency discriminating scratch suppressor, variable expander, with attack control, and high- and low-frequency tone compensation.—RADIO-CRAFT

## CAPACITOR CHECKER

Solar Manufacturing Co.  
New York, N. Y.

The new CF Exam-eter features a patented "Quick-Check" oscillator cir-



cuit for spotting intermittent, open circuited and short-circuited capacitors without the necessity of unsoldering them from the electrical circuits in which they are connected.

For precise qualitative measurements, the instrument contains a d.c. bridge to check capacitances from 10-mmf to 2000 mf and resistances from 100 ohms to 7.5 megohms. Capacitor power-factors up to 55 percent are read on an auxiliary bridge scale.

The 4 1/2-inch meter used in the vacuum-tube-voltmeter bridge null indicator is also used to measure electrolytic capacitor leakage currents under rated voltage from a self-contained continuously-adjustable d.c. voltage supply.

Extra test jacks permit overload-proof external vacuum-tube-voltmeter measurements up to 600 volts d.c. and 50 volts a.c.

An electronic test circuit supplements the bridge for measurements of capacitor insulation resistance up to 10,000 megohms.—RADIO-CRAFT

## VARIAC AUTOTRANSFORMER

General Radio Co.  
Cambridge, Mass.

A new series of Variac autotransformers, designated as Type V-5, is announced to replace the popular Type 200-C models. Intended for the manual control of a.c. voltage, they incorporate improvements in convenience, utility, reliability, appearance, and value.



Rated output current for 115-volt models is 5 amperes; maximum current is 7.5 amperes. Voltage output can be varied from 0 to 17 percent above line voltage. Volt-ampere rating is 0.862 kva. 230-volt models will handle 0.575 kva with current ratings of 2 amperes, rated, and 2.5 amperes maximum.—RADIO-CRAFT

## SELENIUM RECTIFIER

Federal Telephone and Radio Corp.  
Newark, New Jersey

A midget size, 5-plate, square stack Selenium Rectifier has been designed to be used in place of rectifier tubes for modern a.c.-d.c.-battery home portable radio receivers. Radio receivers using this rectifier become operative practically instantaneously, no warm-up period is necessary.

Known as type 403D2625, the rectifier consists of five square selenium plates made on aluminum base plates, con-

nected in series, with center contact. It measures only 1 1/4 x 1 1/4 x 11/16 inches and can be installed in spaces where the ordinary tube will not fit. Only two soldering operations are necessary and a minimum of mounting hardware is needed.

Life of the selenium rectifier is many times that of the type 117Z6 tube it replaces. The unit has a rated current-carrying capacity of 100 milliamperes



d.c. and a peak inverse voltage of 330. The amount of heat dissipated by the rectifier stack is only a fraction of that generated by a 117-volt tube rectifier.—RADIO-CRAFT

## CRYSTAL MICROPHONE

Electro-Voice, Inc.  
South Bend, Ind.

This new E-V Comet Model 902 provides advanced design and engineering in an ultra-modern, high quality low-cost crystal microphone for the home-recording, sound, and communications fields.

Frequency response is substantially flat from 70 to 7000 c.p.s. Output level is 48 db below 1 volt/dyne/cm<sup>2</sup>, open circuit. Voltage developed by normal speech (10 dynes/cm<sup>2</sup>) is .0394 volt. Impedance is Hi-Z. Can be used with any standard amplifier employing high impedance input.



The Model 902 may be used for group pick-up or for a single person. It is particularly suitable for home recording, economical public address systems, paging, and amateur radio communications.—RADIO-CRAFT

PLEASE PLACE YOUR ORDER WITH YOUR REGULAR RADIO PARTS JOBBER. IF YOUR LOCAL JOBBER CANNOT SUPPLY YOU, KINDLY WRITE FOR A LIST OF JOBBERS IN YOUR STATE WHO DO DISTRIBUTE OUR INSTRUMENTS OR SEND YOUR ORDER DIRECTLY TO US.

## The New Model CA-11 SIGNAL TRACER

Simple to operate . . . because signal intensity readings are indicated directly on the meter!



The Model CA-11 comes housed in a beautiful hand-rubbed wooden cabinet. Complete with Probe, test leads and instructions.....Net price

**\$18<sup>75</sup>**

Essentially "Signal Tracing" means following the signal in a radio receiver and using the signal itself as a basis of measurement and as a means of locating the cause of trouble. In the CA-11 the Detector Probe is used to follow the signal from the antenna to the speaker — with relative signal intensity readings available on the scale of the meter which is calibrated to permit constant comparison of signal intensity as the probe is moved to follow the signal through the various stages.

### Features:

- ★ SIMPLE TO OPERATE — only 1 connecting cable — NO TUNING CONTROLS.
- ★ HIGHLY SENSITIVE — uses an improved Vacuum Tube Voltmeter circuit.
- ★ Tube and resistor-capacity network are built into the Detector Probe.
- ★ COMPLETELY PORTABLE — weighs 5 lbs. and measures 5" x 6" x 7".
- ★ Comparative Signal Intensity readings are indicated directly on the meter as the Detector Probe is moved to follow the Signal from Antenna to Speaker.
- ★ Provision is made for insertion of phones.

## The New Model 450 TUBE TESTER



### Specifications:

- Tests all tubes up to 117 Volts including 4, 5, 6, 7, 7L, Octals, Loctals, Bantam Junior, Peanut, Television, Magic Eye, Hearing Aid, Thyratrons, Single Ended, Floating Filament, Mercury Vapor Rectifiers, etc. Also Pilot Lights.
- Tests by the well-established emission method for tube quality, directly read on the scale of the meter.
- Tests shorts and leakages up to 3 Megohms in all tubes.
- Tests individual sections such as diodes, triodes, pentodes, etc., in multi-purpose tubes.
- New type line voltage adjuster.
- NOISE TEST: Tip jacks on front panel for plugging in either phones or external amplifier will detect microphonic tubes or noise due to faulty elements and loose internal connections.
- Works on 90 to 125 Volts 60 Cycles A.C.

**SPEEDY OPERATION** assured by newly designed rotary selector switch which replaces the usual snap, toggle, or lever action switches.

The model 450 comes complete with all operating instructions.

Size 13"x12"x6".

Net weight 8 lbs. **\$39<sup>50</sup>**

Our Net Price.....

## New Model 400 ELECTRONIC MULTI-METER

A Combination Vacuum-Tube Voltmeter and Volt-Ohm Milliammeter plus Capacity, Inductance, Reactance, & Decibel Measurements



### Specifications:

- D.C. V.T.V.M. VOLTS: 0 to 3/15/30/75/150/300/750/1500/3000 Volts
  - D.C. VOLTS: (At 1,000 Ohms Per Volt) 0 to 3/15/30/75/150/300/750/1500/3000 Volts
  - A.C. VOLTS: (At 1,000 Ohms Per Volt) 0 to 3/15/30/75/150/300/750/1500/3000 Volts
  - D.C. CURRENT: 0 to 3/15/30/75/150/300/750 Ma. 0 to 3/15 Amperes
  - RESISTANCE: 0 to 1,000/10,000/100,000 Ohms 0 to 1/10/1,000 Megohms
  - CAPACITY: (In MFD) .0005—.2 .05—20 .5—200
  - REACTANCE: 10 to 5M (Ohms) 100—50M (Ohms) .01—5 (Megohms)
  - INDUCTANCE: (In Henries) .035—14 .35—140 35—14,000
  - DECIBELS: —10 to +18 +10 to +38 +30 to +58
- The model 400 comes housed in a rugged crackle-finished steel cabinet complete with batteries, two sets of test leads, one set of V.T.V.M. probes and instructions. **\$52<sup>50</sup>**
- Size 5 1/2" x 9 1/2" x 10".....Net



# SUPERIOR INSTRUMENTS CO.

Dept. R 227 FULTON ST., NEW YORK 7, N. Y.

# REPAIR RADIOS THIS FAST, EASY WAY!

Complete, easy instructions for diagnosing and repairing common troubles in practically every home and car radio in use today

## NOT A STUDY BOOK!

You don't have to be an expert! You don't have to have a lot of costly test equipment in order to repair most radios—NOT when you have A. A. Ghirardi's famous **RADIO TROUBLESHOOTER'S HANDBOOK** at your finger tips. Bothered with "fading" on a certain model? Noises on another? "Poor volume?" A "dead" set or what-not? Just look up the receiver's make and model in the 404-page Case History Section of the **HANDBOOK**. Nine times out of ten, it will tell you EXACTLY what the trouble is—and EXACTLY how to fix it. No lost time! No needless, tedious testing! The **HANDBOOK** tells you—automatically!

Over 300 additional big manual-size pages contain other invaluable radio service data—Color Codes, Tube Data, and Part Substitutions, I-F alignment and Transformer information and literally dozens of charts, graphs, diagrams, data and helpful hints that will help you repair any radio ever made **EASIER, BETTER and TWICE AS FAST!** Weighs over 4 lbs. Only \$5 on our 5-DAY MONEY-BACK GUARANTEE basis.



### PAYS FOR ITSELF Pronto!

**RADIO TROUBLESHOOTER'S HANDBOOK** will pay for itself in time saved the first time you use it. "Thanks to the **HANDBOOK**, I repaired my radio an hour after it had been returned as 'unrepairable' by a local radio shop," writes J. L. Fizzell of Kansas City. "The Case Histories take you right to the trouble and save hours of testing," says Julius Siske Jr. of Maryland.

## TECHNOTES

### .... INTERMITTENT STATIC

Static and intermittent noises when walking across the floor near a radio may be caused by ungrounded BX cable rubbing against a grounded water or gas pipe. Intermittent contact between BX and any grounded metallic surface may produce static because of difference in potential between the two metals.

To remove this source of trouble, carefully ground each cable.

WILLIAM W. BONN,  
Atlanta, Ga.

### .... RCA 96K2

Intermittent operation of this model have often been traced to poorly soldered connections to the first i.f. transformer. Resoldering all connections in this circuit will cure the trouble.

CLAUDE M. PREW,  
New London, N. H.

### .... RCA R-118 AND R-211

Abrupt fading on these models is caused by the coupling condenser between the 6B7 and 41. This condenser is located on the resistor boards and opens intermittently. Replacement is, of course, the remedy indicated.

JAMES KIRKWOOD,  
Macon, Ga.

### .... PHILCO 40-140

This model frequently develops an intermittent condition. The trouble may often be cured by replacing and relocating the .003- $\mu$ f condenser that is squeezed between the socket of the 7J7 and a terminal strip.

FLOYD D. GOFF,  
Black Mountain, N. C.

### .... RECORD PLAYERS

Low output from record players using one stage of amplification is sometimes caused by replacing the original cartridge with one having a lower output voltage. Replacing such a cartridge with one having 2 to 2.9 volts output will increase the volume considerably.

HOWARD J. MASON,  
Morehead City, N. C.

### .... RCA VICTOR RE-45

Some of these models develop a loud roar that will over-ride the strongest signals. This may be traced to leaky or partially shorted condensers connected from each side of the power line to the chassis. Replace both of these condensers with .01 $\mu$ f, 600-volt tubulars.

CLAUDE M. PREW,  
New London, N. H.

### .... A.C.-D.C. RECTIFIER

Complaint on the set was low volume. All tubes tested good in the tester. All voltages in the set checked low. There were no shorts.

The trouble was located in the 35Z5. Although it tested good in the tester, the internal resistance would rise and the voltage decrease when working into a normal load.

THOMAS J. ROSENTHAL,  
Corvallis, Oreg.

ONLY \$5



# Prepare for a Real Future in PROFESSIONAL RADIO-ELECTRONIC REPAIR WORK

LEARN AT HOME .... without an Instructor

Ghirardi's famous **MODERN RADIO SERVICING** is the only single, inexpensive book giving a complete course in electronic servicing by scientific professional methods. Contains over 706 clear illustrations. Quick to read—amazingly easy to understand.

Who will service the millions of new radios, and complicated new television, F-M and facsimile equipment to be sold within the next few years? Who will install and service the countless electronic devices now going into industry? Never before has there been such a demand for professionally-trained technicians who know their stuff—and this means training of exactly the type that A. A. Ghirardi gives you in his big 1300-page, profusely illustrated **MODERN RADIO SERVICING**. It is the ideal book for home study! Explains all types of service test instruments and how to use each one; how to make preliminary trouble checks; how to analyze circuits scientifically; how to troubleshoot; how to repair or replace parts or make substitutions; how to install equipment—and literally hundreds of additional subjects including How to Start and Operate a Successful Service Business of Your Own. Sold on 5-DAY MONEY BACK GUARANTEE. You Can't lose. Send coupon today!

## MAIL ORDER . . . Rush Coupon Now!

Murray Hill Books, Inc., Dept. RC-86  
232 Madison Ave., New York 16, N. Y.

Enclosed find \$\_\_\_\_\_ for books checked; or  send C.O.D. (no foreign C.O.D.'s) for this amount plus postage. It is understood I may return the books for refund of my money within 5 days if not fully satisfied.

**RADIO TROUBLESHOOTER'S HANDBOOK** \$5 (\$5.50 foreign)  **MODERN RADIO SERVICING** \$5 (\$5.50 foreign)

**Money-Saving Combination;**

Both big books, over 2040 pages of the finest service data money can buy—only \$9.50 for the two (\$10.50 foreign).

Name .....

Address .....

City & Dist. No. .... State .....

## GET BOTH BOOKS AT A BARGAIN

Let Ghirardi's **RADIO TROUBLESHOOTER'S HANDBOOK** save you time and money on common radio service jobs—let **MODERN RADIO SERVICING** train you for complete professional, electronic service training!—Get BOTH BIG BOOKS at the special price of only \$9.50 for the two. Use coupon today. Check "MONEY-SAVING COMBINATION OFFER."

## 5-DAY MONEY-BACK GUARANTEE



.... AUTO RADIOS

1—In many automobile sets, the pilot lamp lead is not sufficiently shielded and one-half inch of unshielded lead will radiate ignition noises. Complete shielding of the lamp will remove the trouble.

2—Low tension noise radiation may be caused by ammeter or gas-gauge circuits. Standard ignition noise by-pass condensers have little or no effect on the radiations. Using smaller condensers will often eliminate the trouble.

In one case, .01- and .02- $\mu$ f condensers were used with "fair" results, but when a .15- $\mu$ f condenser was tried, the trouble disappeared.

A. MALOWANCHUK,  
Medicine Hat, Alberta

.... RADIO-PHONO SWITCH

Occasionally a radio service man is called upon to install a tone control or phono jack on a radio set that was not equipped with one originally. The problem of mounting the control or phono-radio switch without disturbing the symmetry of the other controls is not always a simple one. If the set is equipped with pushbuttons of the "electric" type, (a separate tuned circuit for each push button setting) it is a simple matter to disconnect the leads to one pushbutton switch and use this push-button for a two position tone control or a phono-radio switch.

HUBERT WATKINS,  
Gulfport, Miss.

.... RCA MODEL 24BT-2

Oscillations or motorboating is a frequent complaint on this model. If the i.f. transformers are slightly detuned, the oscillations cease, but there is a loss in volume. Replacing the 10- $\mu$ f filter condenser will completely eliminate the trouble. This filter condenser will frequently test "good," but still have increased in a.c. resistance sufficiently to cause trouble.

EDWARD DENHAM,  
Steele, Mo.

.... RCA 9TX50

The owners complain of intermittent disturbances. This is often caused by the type of condensers used in the grid lead of the 12SQ7 and the plate by-pass circuit of the 35L6. These condensers are so constructed that the "pig-tail" leads pull away from the foil. If the condenser case can be twisted without twisting the leads, separation of the foil from the lead is indicated. Such condensers should, naturally, be replaced.

CHARLES MCCLESKEY,  
Baton Rouge, La.

.... PHILCO MODEL 46-1201

This phono-radio combination played perfectly on "radio" but distorted when playing a phonograph record. It was found that the crystal cartridge was not shock-mounted.

The condition was cured by removing the crystal and inserting a thin sheet of rubber between it and the tone arm. This cleared up the trouble entirely.

B. S. NORKUS,  
Stratford, Conn.

**"THIS EASY, INEXPENSIVE BOOK  
WILL GIVE YOU a Complete Mastery  
OF BASIC RADIO-ELECTRONICS"**

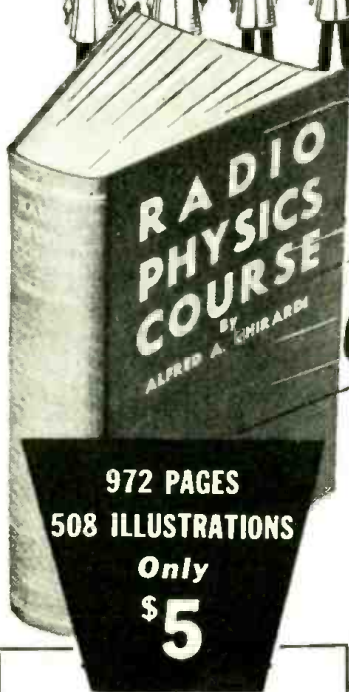
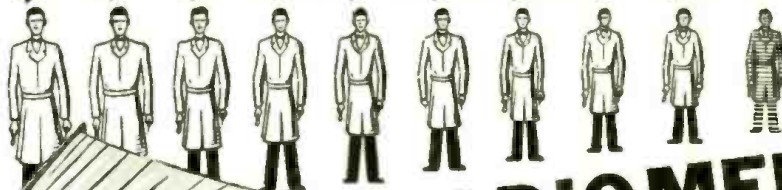

972 PAGES  
508 ILLUSTRATIONS  
Only  
**\$5**

**9 RADIOMEN  
OUT OF 10  
Can't be Wrong!**

Train now for a successful career in RADIO-TELEVISION-ELECTRONICS! Before spending a lot of money on your training, however, it pays to find out what training the successful Radio-Electronic men of today themselves prefer. What training do they recommend—and is it possible that a single big, 3½ lb., 972-page book priced at only \$5 can do as much or more for you than a lesson course selling for more than ten times this amount? Let a mixed group of 817 industrial electronic experts, radio repair men, instructors, and students give you the answer:

**724 OUT OF 817**

When we asked them to tell us exactly what they thought of the various radio-electronic books and courses, 724 of these men—9 OUT OF 10—answered that Alfred A. Ghirardi's RADIO PHYSICS COURSE book is their choice as the best buy on the market—the easiest to understand—and far better than any other book or course they had ever seen! What better proof could you ask than this?

Read the book yourself for 5 full days. Compare it page for page with any similar instruction of which you have ever heard. If not more than satisfied, return the book. EVERY CENT OF YOUR MONEY WILL BE REFUNDED and no questions asked!

**LEARN AS FAST AS YOU CAN READ!**

You'll understand every word of Ghirardi's RADIO PHYSICS COURSE without previous training. You'll be pleasantly surprised how you'll quickly master the subjects that other books and courses make seem very complicated.

RADIO PHYSICS COURSE is the most complete training money can buy. Starting with BASIC ELECTRICITY, it takes you step by step through the entire field of RADIO-ELECTRONICS-TELEVISION to the latest developments. Everything

is made crystal clear. You buy it for only \$5 complete—and you progress as fast as your spare reading time permits. Many students have completed it in a few weeks!

If you're anxious to get off to a flying start in the fascinating, big-paying field of RADIO-ELECTRONICS-TELEVISION, this is the book for you! Our 5-Day Money-Back Guarantee is your absolute protection. You cannot lose!

ALFRED A. GHIRARDI

**I'LL TRAIN YOU AT HOME  
FOR A PROFITABLE  
FUTURE IN THE FASTEST  
GROWING INDUSTRY IN  
THE WORLD!**



**5 DAY MONEY-BACK GUARANTEE**

MURRAY HILL BOOKS, INC., Dept. RC-86,  
232 Madison Ave., New York 16, N. Y.

Enclosed find \$\_\_\_\_\_ for which please rush a copy of Ghirardi's 972-page RADIO PHYSICS COURSE book, or  send C.O.D. (no foreign C.O.D.'s) for this amount plus postage. It is understood I may return the book in 5 days for full refund if not more than satisfied.

Name \_\_\_\_\_  
Address \_\_\_\_\_  
City & Dist. No. \_\_\_\_\_ State \_\_\_\_\_

**FOR BEGINNERS**

**... 36 Courses  
in One!**

EVERYTHING ABOUT RADIO, SOUND, ELECTRICITY, ELECTRONICS: RADIO broadcasting Systems; Sound, Speech and Music; Electron Theory; Electric Current; Electrical Units; Ohm's Law; Resistance; Electrical Circuits; Batteries; Electromagnetism; Electro-magnetic Induction; Inductance and Inductors; Capacitance and Condensers; Alternating Current Circuits; Electric Filters; Electrical Measuring Instruments; Electro-magnetic Radiations; Radio Transmission; The Broadcasting Station; The Receiving Station; Elementary Study of the Vacuum Tube; Vacuum Tube Detector & Amplifier Action; Tube Characteristics; Radio-Frequency Amplification; Superheterodyne Receivers; Amplifier and Tuning Coils; Audio Amplification; Battery & Electric Operated Receivers; Auto-Radio; Aircraft Radio; Phonograph Pickups; Public Address Systems; Short-Wave Receivers; Photo-Electric Cells; Television; Testing and Servicing; Sound Motion Pictures—and dozens of other subjects.

**IMPORTANT!**

There is no guess work when you buy Ghirardi's RADIO PHYSICS COURSE. Sales records prove that this big book and its tested instruction material is more widely used for home study, and by more Signal Corps, Navy, and civilian schools and colleges than any other of its kind!

# CALRAD "hard-to-get" RADIO VALUES!

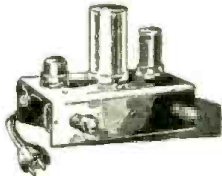

## SPECIAL! TWO-TUBE PHONO OSCILLATORS

Make any record player wireless with brand new  
Operates as far as 100 feet from a radio and can be used with Automatic Record Changers, Players or Microphone.

Uses 1-12SH7 and 1-12H6 Tubes. Complete with tubes \$8.75 net. Supplied in kit form with "easy-to-follow" instructions for assembly. Complete with all parts, instructions and tubes

**\$4.95**  
net

## 4 Prong Universal Vibrator

Fits 80% of all replacements. Individually boxed.

**\$1.25**  
each



## CRYSTAL MIKE

With 100 ft. Shielded Mike Cable

**\$7.95**  
each

## AUTO ANTENNAS

- 3 Section
- 66" Long
- Brass Tubing
- Triple Chromium Plated
- 2 Insulator Type Cowl Mounting With Lead Individually Boxed

24 TO MASTER CARTON **\$30.00**

LOTS OF 48 **\$55.00**

Immediate Delivery But Quantity Is Limited.

## 5 Tube Super AC-DC PARTS KIT

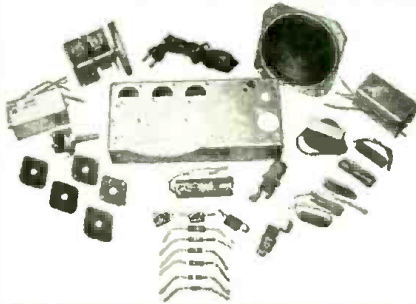

Kits include: Stamped Chassis-Dynamic Speakers—Output Transformer—Volume Control and Switch—2 Shielded I.F. Coils—Antenna and Osc. Coils—Two-gang Super Variable—50 Octal Sockets—20 x 20 Mfd. 150 Volt Filter—5 Tubular Condensers—3 Mica Condensers—6 Resistors—6 ft. AC Cord and Plug—Circuit Diagram.

While They Last **\$8.95 ea.** Lots of 6 **\$50.00**

## Signal Corps TELEGRAPH KEYS

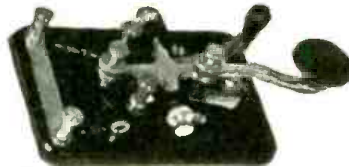

Genuine U.S. Signal Corps telegraph keys brought to you at prices below manufacturing cost! Made with switch to close contacts, polished durable enameled metal base mounted on a bakelite base; key lever is nickel-plated; contacts are brass-silver. Packed in new original boxes.

LOTS OF 60c each CARTON OF 30 **50c each**

## V. M. TWO POST RECORD CHANGER



This Record Changer is a well-made mechanism, will play either 10-in. or 12-in. records. The pickup uses a crystal cartridge. Size 14 in. x 14 in. Packed 2 to a factory-sealed carton, factory guaranteed.

CARTON OF 2 **\$35.00 Special \$18.95 ea.**

## WEBSTER RECORD CHANGER

Model 50 Complete



**\$19.95**  
each

LOTS OF 3  
**\$19.00**

Built to last. Fast change cycle. Simple, fool proof operation. Feather light needle pressure. Longer life for records. Quiet running shock mounted motor.

# BUY NOW! LOWEST PRICES! STOCKS LIMITED!

Fully Shielded Power Transformers  
50 Mfd.—6.3 Va. @ 2 amp. C.T.—5 Vo. @ 2 amp. C.T.—\$50 Vo. C.T. \$2.45 ea. Lots of 10—\$22.50 ea.  
Push Pull 6L6 Shielded Output Transformer  
30 Watt Peak. to 2-4-6-8-16-250 and 500 ohm line. \$3.45 ea. Lots of 12, \$3.25 ea.

Push Pull Input Transformer, 10,000 ohm plate to push pull 6L6—\$1.10 ea. Lots of 12—\$1.00 ea.  
Midget Universal Output Transformer—push pull plate to 2-4-6-8-10-16 ohm voice coil—95c ea. Lots of 10—85c ea.  
10 Watt Large Universal Output—\$1.35 ea. Lots of 10—\$1.20 ea.

Single Pentode Midget Output—for 50L6, 6V6, 6F6, etc.—55c ea.  
50 Mill Filter Choke 300 ohm—65c ea. Lots of 10—60c ea.  
75 Mill Filter Choke 250 ohm—95c ea. Lots of 10—85c ea.  
100 Mill Filter Choke 250 Ohm—\$1.10 each. Lots of 25—\$1.00 ea.

**DYNAMIC AND P.M. SPEAKERS**  
4-in. 450-Ohm Dynamic—Packed 30 to Carton—\$1.75 ea.  
4-in. 2500-Ohm Dynamic—Packed 30 to Carton—\$1.75 ea.  
4-in. P.M. Heavy Slug—Packed 30 to Carton—\$1.70 ea.  
5-in. P.M. Heavy Slug—Packed 30 to Carton—\$1.75 ea.  
6-in. P.M. Heavy Slug—Packed 20 to Carton—\$2.25 ea.

**TUBULAR ELECTROLYTIC CONDENSERS**  
10 Mfd. 50 Volt—21c ea.  
25 Mfd. 50 Volt—24c ea.  
50 Mfd. 50 Volt—28c ea.  
100 Mfd. 50 Volt—35c ea.  
16 Mfd. 150 Volt—25c ea.  
20 Mfd. 150 Volt—29c ea.  
30 Mfd. 150 Volt—32c ea.  
50 Mfd. 150 Volt—35c ea.  
20 x 20 Mfd. 150 Volt—43c ea.

30 x 20 mfd. 150 Volt—47c ea.  
40 x 20 Mfd. 150 Volt—55c ea.  
50 x 30 Mfd. 150 Volt—65c ea.  
20 Mfd.—350 Volt—38c ea.  
10 Mfd.—300 Volt—38c ea.  
20 Mfd.—25 Volt—39c ea.

**Standard Brands, Tubular By-Pass Condensers**  
.001-.002-.003-.005-.006-600 Volt ..... \$6.75 per 100  
.025-.01-.02-600 Volt ..... \$7.75 per 100  
.05-600 Volt ..... \$8.50 per 100  
-1-600 Volt ..... \$9.50 per 100  
.25-600 Volt ..... \$15.00 per 100  
.5-600 Volt ..... \$19.00 per 100  
4 Mfd. 600 Vo. T.L.A. Oil Condenser, screw base, Upright aluminum can, 1/2 in. x 3/4 in. List \$4.50, Replaces 8 mfd. 600 Vo. electrolytic. 95c ea.

**FINEST QUALITY MIDGET MICAS:**  
.001-.0001 .005-.00005 \$5.00 per 100  
.002-.00025 .006-.0005 \$40 per 1000  
Astaire Low Pressure, curved arm, crystal pickup with Sapohire Stylus Permanent Needle, has cartridge which replaces LP6-LP21-LP23. \$3.50 ea.; Lots of 10 \$32.50.  
Standard Low Pressure Crystal Pickup. \$2.25 ea.; Lots of 10—\$20.00  
Signal Corps Dual Headsets—8000 ohms high impedance, with 2 rubber ear cushions, cord and phone plug, individually boxed, \$12.50 list, net \$2.25 ea., lots of 12, \$25.

456 K.C. Antenna, Oscillator and R.F. Coils. 25c ea.  
456 K.C. I.F. Coils Input & Output, medium size can ..... 59c ea.  
Weston Volt ohm meter Model 663—\$49.50 with carrying case & leads.  
Mallory No. 534C—6 prong, 6 Volt, Synchronous Vibrator, Equivalent to Mallory No. 742. \$1.75 ea. Lots of 10—\$15.00.  
Kit of 50 assorted Bakelite Knobs for 1/2-in. shaft, with set screws ..... \$2.50 per kit  
Kit of 50 assorted wood knobs for 1/2 in. shaft with set screw—\$3.50 per kit.  
Midget Ceramic Trimmers—3—30 mmf., \$6.00 per 100

Western Electric—0-200 Microammeter—3 in bakelite case, \$4.25 ea.  
Tinned Copper Shielding—1/4 in., 1/2 in., 3/4 in. \$1.50 per 100 ft.  
Rubber Sheathed "Mike" Cable, shielded, single Conductor 100 ft. for \$ 3.95  
500 ft. for \$25.00  
Moulded Local Sockets 1/2-in. mts. with metal ring \$7.00 per 100  
6 ft. A.C. Cords with plug ..... \$20.00 per 100

Volume Controls, less Switch—1/2-in. shaft  
250,000 ohm.  
1 Meg Lots of 100 39c each  
2 Meg \$30.00

250 ft. Coll Underwriter Approved Zip Cord—\$4.75 per coil.

Transmitting type variable Condensers, Dual Double Spaced 110 Mfd. per section \$1.00 ea.  
Dual Double Spaced 170 Mfd. per section \$1.00 ea.  
Single Gang Dual Spaced 440 Mfd.—\$1.00 ea.  
Single Bearing Midget Condenser 14 plate—100 Mfd. 50c ea.

Midget Open Circuit Jack—Lots of 10—\$1.50  
Midget Closed Circuit Jack—Lots of 10—\$2.00  
Midget Double Circuit Jack—Lots of 10—\$2.00

Insulated Banana Tip Jacks, red or black \$8.50 per 100  
Insulated Banana Plugs, solderless, slide screw connection, red or black ..... \$10.00 per 100  
Standard Barrel Type Phone Plug ..... \$20.00 per 100  
Patch Cord 4 ft. with 2 P.L. 55 Plugs—49c ea.  
4 Tap Midget Loop Antenna Snee 7 3/4"x5"—35c ea.  
500,000 Ohm Volume Control with Switch—2" Shaft 69c. ea.  
1 Meg Ohm Volume Control with Switch—2" Shaft 69c. ea.  
10 Watt Wire Wound Resistors, your choice of sizes 25 Ohm to 25,000 Ohm—20c ea.—\$17.50 per 100  
Buffer Condensers (Famous Make) .005, .01, .02—1700 Volt—19c ea. Lots of 50—15c ea.

**MAIL ORDERS FILLED:** 25% deposit with order, balance C. O. D. References—Bank of America, Santa Monica & Vermont Avenues Los Angeles, California

# CALIFORNIA RADIO & ELECTRONICS CO.

Dept. No. C. 711 No. Vermont Ave., Los Angeles 27, California

A

is for the articles a good radio serviceman should read.

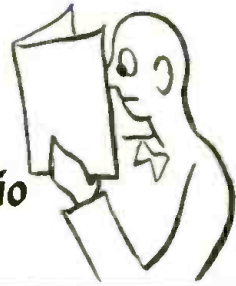

B

is for the business news he must keep up with.



C

is for the continuous stream of new developments in the field.



and  
RM

is for  
**RADIO MAINTENANCE  
MAGAZINE**

which contains all the ABC's of radio and brings a wealth of this valuable material every month.

**ONLY \$3<sup>00</sup> FOR 24 ISSUES**

**Radio Maintenance is not sold on newsstands**



**YOU GET THE LATEST IN**

**AM • PA • FM • TELEVISION**

Servicing "Know-How"  
Lessons from military servicing.  
Short cuts and Speedups.  
Better Use of Test Equipment.  
Money in Proper Shop Layout.  
Modern Bench and Tool Equipment.  
Large, easy-to-read Schematics.  
Trouble-shooting procedures.  
Aligning new and old models.  
Contacting Prospective customers.  
News of the service profession—and many other timely, authentic subjects.

**RADIO MAINTENANCE  
MAGAZINE**  
460 BLOOMFIELD AVE.,  
MONTCLAIR, N. J.

Please send me  
**RADIO MAINTENANCE**

- For 1 year 2.00
- For 2 years 3.00

- CHECK ENCLOSED\*
- BILL ME LATER

\*NOTE: By enclosing payment, thus eliminating billing expense

**WE WILL ADD ONE ISSUE FREE!**

*Special offer to  
Radio Servicemen*

RC-8

NAME \_\_\_\_\_

OCCUPATION \_\_\_\_\_

ADDRESS \_\_\_\_\_

CITY \_\_\_\_\_

ZONE \_\_\_\_\_ STATE \_\_\_\_\_

**SERVICEMEN ARE HONEST**

Fifty-five percent of the radio shops canvassed by a non-technical shopper for a big metropolitan daily are to be recommended on a basis of servicing charges and operating policies. This will be welcome news to the serviceman, who has been used to surveys which show him up in an unfavorable light. The forty-five percent "not recommended" were not necessarily classed as "gyps" but other considerations such as high prices were taken into consideration.

The survey was made by the New York City newspaper *PM*, and was carried out by a person unfamiliar with the technical side of radio. A set which was actually defective was used, in sharp contrast to a famous survey made some years ago, in which defects were faked. This offered the shops a genuine repair job to estimate, and was no doubt responsible for the higher number of shops found to be competent to do an honest and reasonably-priced job.

Before taking the set to the first shop, a radio engineer, Herbert Roth of the Electronic Corporation of America was called to determine the trouble and to estimate a reasonable charge for putting the set into first-class operating condition. He found the following troubles:

Pilot light burned out. Replacement cost approximately 10c.

One section of an electrolytic condenser bank partially open, causing oscillation at high volume levels. Entire condenser should be replaced at approximate cost of \$1.50.

Condition of set indicated that thorough cleaning and realignment would be necessary. This service would cost approximately 50c (!—*Editor*) when accompanied by other services. Line cord broken at plug. Replacement; 25c. All tubes tested were serviceable although the condition of three indicated that replacement was advisable for reliable service. The replacement cost of these tubes was estimated at \$3.25.

The total cost of repair work was estimated at \$4.00 to \$5.00 without new tubes. If these were replaced, the cost would rise to a maximum of \$7.00.

Of the ten shops canvassed with the radio, *only two* erred in their diagnosis. Prices, however, varied from \$4.75 to \$8.00. The highest price quoted by a "recommended" shop was \$7.10. Five of the shops were recommended on the basis of the charges and operating policies.

Several of the shops have service fees ranging from 50 cents to \$1.50 as compensation for the time spent in determining the faults in the set. Two of these shops impose fees only when they are not permitted to make the repairs. Another shop terms this an extra service and it is added to the repair

(Continued on page 779)

**Highest Quality  
RADIO and ELECTRONIC  
Testing Equipment**

**IMMEDIATE DELIVERY FROM STOCK GUARANTEED**

**WESTON  
OHMMETER**

Model 689-1F

Net Price: \$14.85



This Ohmmeter has a double range of 0-10 and 0-1000 ohms for the accurate measurement of low resistance values. This type is widely used for production testing armature and field resistances of small motor relays and coil testing, transform, winding tests and other similar appliances. Complete with operating instructions, test leads and leather carrying case.

*The New  
Model S-10-A*

**Pocket Size  
Oscilloscope**

Net Price: \$55.00



Complete cathode ray oscilloscope incorporating the cathode ray tube, vertical and horizontal amplifiers, linear time base oscillator, synchronization means and self-contained power supply. Complete with tubes and operating instructions.

*The New  
Model 543-S*

**SUPREME  
MULTIMETER**

Net Price: \$24.75



**1% WIRE WOUND  
PRECISION RESIS-  
TORS.** Ranges at 1000 ohms per volt standard sensitivity. Full size 3" square meter with a rugged, accurate 200 microampere movement and a knife edged pointer. All ohmmeter ranges, including the megohm range are operated by batteries and contained within its durable black molded bakelite case.

*The New  
Model 274*

**Dumont Five-Inch  
Oscilloscope**

Net Price: \$99.50



**Input Impedance: Y**  
Axis: Direct 5 meg., 60 μf. X Axis: Direct 5 meg., 80 μf. Z Axis: 10 rms. volts to blank. Y Amplifier: 1 meg., 70 μf. X Amplifier: 5 meg., 30 μf. Sine wave response uniform within 20% from 20 cycles to 50 KC. Continuously variable frequency range from 8 c.p.s. to 30 KC. Synchronizing signal sources: internal or external.

**McMurdo Silver  
Model 904**

**Capacitance  
Resistance  
Bridge**

Net Price \$49.90



¼ mmfd/ohm thru 1,000 mfd./megohms; 0-50% power factor; 0-500 volt adjustable internal polarizing voltage; 0-10 and 0-100 ma. electron-ray leakage current meter; measures resistance, capacitance under actual operating voltages!

*The New  
Model 705  
Signal  
Generator*

Net Price \$49.50



**RANGES:**  
From 95 kc to 100 mc, continuously variable. Calibration accurate to 2% through broadcast bands, within 3% for high frequency bands. Planetary drive condenser, direct reading calibration, output modulated or unmodulated. Self-contained electronic modulation 400c sine wave available for external use. Special feature provided in having two degrees of modulation at both approx. 30% and 80%.

*McMurdo Silver  
Model 905  
"SPARX"*

**Dynamic  
Signal Tracer**

Net Price \$39.90



Frequency range from 20 cycles to over 200 megacycles. Contains isolating capacitor, resistor and one of the new radar u.h.f. crystal diodes. Loads a circuit being tested with only 3 mmfd. and higher than .5 megohm.

*The New Model  
802N Com-  
bination*

**TUBE & SET  
TESTER**

Net Price \$59.50

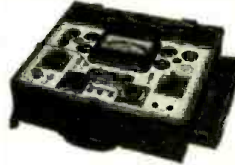

1000 ohms per volt. Four Range A.C. Voltmeter: 0/10/50/500/1000. D.C. Milliammeter: 0/1/10/1000 DC Ammeter 0/10. DB Meter: —8/15/15 to 29/29/ to 49/32 to 55 decibels. Four Range Output Meter—same as AC Volts.

SUPREME Model 599 Tube and Set Tester.....	\$2.50
SUPREME Model 865 Vacuum Tube Voltmeter.....	\$3.50
R.C.P. Model 448 Pocket Multimeter.....	24.50
R.C.P. Model 424A Volt-Ohm-Milliammeter.....	29.50
R.C.P. Model 864 Electronic Multimeter.....	48.00
R.C.P. Model 315 Tube Tester.....	59.50
R.C.P. Model 485A Ultra-Sensitive Multimeter.....	71.50
R.C.P. Model 668 Vacuum Tube Volt-Ohm- Capacity Meter.....	74.50
R.C.P. Model 805 Tube and Set Tester.....	89.50
R.C.P. Model 668 A.V.T. Volt Ohm Megger.....	94.50
Insulation Tester.....	27.50
Reiner Model 333 Master Tester.....	95.00
Reiner Model 530 Squarewave Generat- Reiner Model 451 Vacuum Tube Volt-Ohm Milliammeter.....	150.00

Superior Model CA-11 Signal Tracer.....	18.75
Superior Model 1553 Volt Ohm Milliammeter.....	24.75
Superior Model 680 5000 Ohms Per Volt V.O. Milliammeter.....	27.65
Superior Model PB-100 Volt Ohm Milliammeter.....	28.40
Superior Model 450 Tube Tester.....	39.50
Superior Model 650 Signal Generator.....	48.75
Superior Model 720 Multi Range AC Ammeter Superior Model 600 Combination Tube and Set Tester.....	49.50
SHALLCROSS Decade Resistance Boxes.....	62.50
SHALLCROSS portable Galvanometers.....	13.50
SHALLCROSS Model 630 Wheatstone Bridge.....	27.50
SHALLCROSS Model 637 Kelvin Wheatstone Bridge.....	75.00
RECORD CHANGER Model VM-200.....	100.00
RECORD CHANGER Model Maguire.....	22.50
RECORD CHANGER Model Maguire.....	24.50

Write for our FREE New POST-WAR CATALOGUE!

**Metropolitan**

**ELECTRONIC & INSTRUMENT CO.**

Dept. C, 6 MURRAY STREET  
NEW YORK 7, N. Y., U. S. A.

Cable Address: METRONICS  
Phone: BARclay 7-5556

**JUST OFF  
THE PRESS**

# RADIOMAN'S HANDBOOK

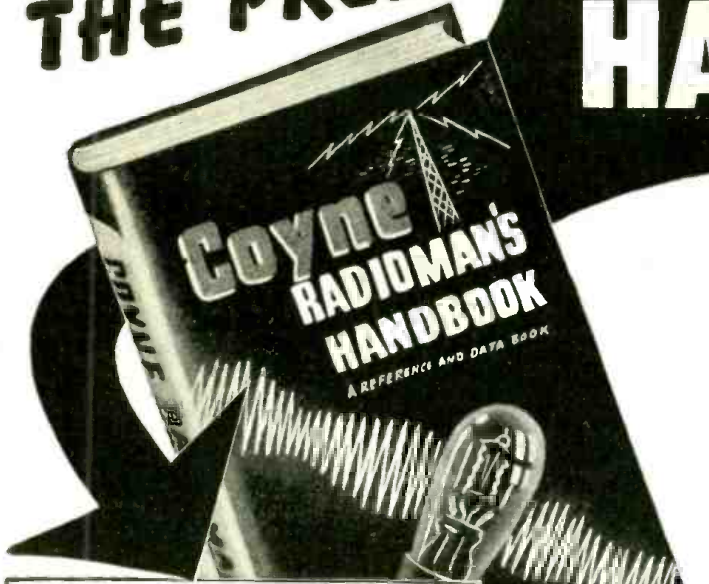

## WHAT THIS GREAT BOOK CONTAINS

- |                           |   |
|---------------------------|---|
| Radio Materials           | Radio Resistance & Insulation (wire tables, etc.) |
| Radio Abbreviations       | Capacitors & Capacitance                          |
| Radio Circuits            | Coils & Coil Winding                              |
| Power Formulas            | Resonance & Coupling                              |
| Radio Receiving Tubes     | Power Supply—A.C. or D.C.                         |
| Reactance & Energy Losses | Power Supply—Batteries                            |
| Radio Transformers        | Oscillators & Antennas                            |
| Radio Amplifiers          | Meters & Measurements                             |
| Radio Receivers           |   |
| Sound Systems & Devices   |   |
| Radio Symbols             |   |

**\$3.25**

## A Brand New, Valuable Reference Book for Men Working in Radio or Electronics

This is the book that radio men everywhere have been waiting for. No matter what work you do in radio, this reference handbook will prove mighty valuable since it contains exactly the information you need. You can refer to it easily right on the job. It should help you get jobs done quicker and better—it will save you valuable time. I'm so sure that you wouldn't part with this book for many times its cost that I'm willing to send it to you for a 7 day FREE examination.

### 7 DAYS' FREE EXAMINATION

You can't expect to carry all the necessary information you need on a job in your head. But with this book at your side you will be able to make quick calculations that will help to show the boss that you certainly know plenty about radio construction, design, installation and operation. As you look through the pages of this valuable Radio Handbook you can easily see how the tables, charts, diagrams and information can help you get more money for your services. So I want you to examine this fine book at **ABSOLUTELY NO COST TO YOU** before you make up your mind whether or not you want it.

### A PRACTICAL REFERENCE BOOK—NOT A TEXT BOOK

You won't need to "study" this book—it is *not* a textbook. Every subject is indexed and condensed. It is full of valuable tables that will help you in your daily work. When you are "on a spot" just turn to the quick reference index, look up the subject you want and you'll find it thoroughly explained with helpful diagrams and tables. You lose no time. You waste no effort. The book is a day-by-day helper to you and will be of value to you on every job you undertake. It was written by competent, experienced, practical radio engineers and instructors. Every diagram has been fully tested in the great Coyne Electrical Shops. Every table is scientifically correct.

## FREE TRIAL COUPON

H. C. Lewis, President, COYNE ELECTRICAL SCHOOL, Dept. C6-T1  
500 S. Paulina Street, Chicago 12, Illinois

Send me the **COYNE RADIOMAN'S HANDBOOK** for 7 days' FREE examination. After 7 days I'll either return the book and owe nothing or I'll send you a check or money order for \$3.25.

Here are other Coyne Books—I'll send any or all on some 7 day Free Examination Offer.

**Coyne Applied Practical Electricity**—7 volume set; a complete library on everything electrical in easy to understand form. \$19.75 cash or \$21.00 on time—\$3.00 after 7 days and \$3.00 per month—1 year FREE Consultation Service and Technical Bulletins.

**Coyne Electrical & Radio Trouble Shooting Manual**—612 pages, over 500 wiring diagrams, hookups. Radio, P. A. systems, radio testing, refrigeration, motors and controls. \$9.00 cash—\$9.95 on time—\$3.00 after 7 days and \$3.00 monthly—1 year Technical Bulletins Free.

**Coyne Electrician's Handbook**—400 pages; data, diagrams, circuits, installation, wiring methods, etc. \$3.25 after 7 days.

**Coyne Electronics for Radlomen & Electricians**—over 400 pages; clearly explains all types electronic tubes, hundreds of diagrams, etc. \$4.95 after 7 days' examination—1 year Free Technical Bulletins.

**Electrical & Radio Dictionary and Data Book**—3300 electrical and radio, radar, electronic and atomic energy terms. 300 pages, vest pocket size. \$1.50 after 7 days.

Name \_\_\_\_\_ Age \_\_\_\_\_

Address \_\_\_\_\_

Town \_\_\_\_\_ Zone \_\_\_\_\_ State \_\_\_\_\_

Where Employed? \_\_\_\_\_

If you prefer to pay postman cash price indicated above when books arrive check here. Same 7 day examination and money-back guarantee of satisfaction.

## SEND NO MONEY SEE THIS BOOK FREE

I am not asking you to send any money—not a single penny. I am so sure this is the book you want and need that I will send it to you to examine for 7 days FREE. Then you look it over and you decide. If it isn't all I claim, then send it back and you owe nothing. If you are convinced that this book is worth many times its cost, then send \$3.25 at the end of 7 days and the book is yours. Send the coupon now, while it is before you!

SEE OTHER COYNE BOOKS IN COUPON

**COYNE ELECTRICAL SCHOOL**  
500 SOUTH PAULINA ST.  
DEPT. C6-T1 CHICAGO, ILL.



*Mr. Radioman:* **Here's How Capitol Radio Can Prepare You Now for a Better Job and a Secure Career in Radio-Electronics . . . !**

**Add CREI Technical Training to Your Present Experience—Then Get that Better Radio Job You Want—More Money, Security!**



CREI home study training in Practical Radio-Electronics Engineering equips you with the ability to go after—and get—a better job in radio-engineering that offers security, advancement and importance.

We are now entering a period where employers can once again afford to be “choosey” in selecting the best-qualified men for the important jobs to be filled.

In our proved course of home study training, you learn not only *how* . . . but *why!* Your ability to solve tough problems on paper, and then follow with the necessary mechanical operation, is a true indication that you have the *confidence born of knowledge* . . . confidence in your ability to get and to hold the type of radio job you want.

CREI courses have been studied by more than 10,000 professional radiomen—so don't say YOU haven't the time. CREI courses are designed to be studied in the most crowded schedules—without in-

terfering with your present work, yet helping you as you progress lesson by lesson.

Now you can read what these typical CREI students have to say. They are men who had the initiative to get started on their own betterment program toward better jobs and more money. You have the same opportunity. It costs you nothing but a moment's time to send for complete details in free book.

**"I give CREI full credit for my securing the position as Asst. Chief Engineer . . ."**

W. H. MEINERS, 420507

**"In the past 7 months I have received 3 increases in salary and a promotion that can be partly credited to CREI . . ."**

C. B. McKNIGHT, 401101

**"There are many times where what I am studying in the course works right in with the immediate problems of my job . . ."**

C. I. CARPENTER, 411024

*CREI Training for Veterans is Approved Under the "G.I." Bill*

## Capitol Radio Engineering Institute

E. H. RIETZKE, President

Dept. RC-8, 3224—16th Street and Park Road, N. W.,  
Washington 10, D. C.

### Branch Offices:

NEW YORK CITY (7)  
170 Broadway

CHICAGO (2), ILL.  
30 N. LaSalle St.

SAN FRANCISCO (2),  
CALIF., 760 Market St.

SAN DIEGO (1), CALIF.  
316 C Street

**• WRITE TODAY for FREE BOOKLET**



**"Your Opportunity in the New World of Electronics"**

If you have had professional or amateur experience—let us prove to you that we have something you need to qualify for a better radio job. To help us to intelligently answer your inquiry—PLEASE STATE BRIEFLY YOUR BACKGROUND OF EXPERIENCE, EDUCATION AND PRESENT POSITION.

Member: NATIONAL HOME STUDY COUNCIL • NATIONAL COUNCIL OF TECHNICAL SCHOOLS

**TELEVISION FOR TODAY**

(Continued from page 760)

signal would occupy a band extending  $\pm 4$  mc about the carrier, or a total spread of 8 mc.

It is possible, however, to eliminate one set of sidebands (in this case, the lower set) because identical information is contained in each set. The result is the carrier and one sideband, permitting a more efficient use of the available frequency spectrum. To minimize the effect of the cleavage on the upper set of sidebands, and keep distortion low, the separation is accomplished gradually.

As a result, 1.25 mc of the lower sideband is left in the signal. This form of operation is known as quasi-single-sideband or *vestigial sideband* operation.

The proportioning of the vestigial side band signal is indicated in Fig. 6. The carrier is located 1.25 mc from the edge of the band. Then for 4 mc above the carrier we have the video information. The video signal and the FM audio carrier are separated by 0.5 mc. This is provided to separate these two components at the receiver and also to prevent interaction between them. The FM carrier swings a maximum of  $\pm 25$  kc to produce its sidebands. Contrast this with the  $\pm 75$  kc swing used by regular FM broadcast stations.

**Simon's - WEST VIRGINIA'S LARGEST RADIO SUPPLY HOUSE!**

**AMPLIFIER for GUITAR or PHONO**



- \* TUBES, 6SJ5, 6J5, 6L6, 5V4G
- \* 4 Tubes—Hi Gain
- \* Two Microphone or Instrument Inputs
- \* Phono Input
- \* 6 1/2 Watts—Beam power
- Complete With Tubes—List \$59.50

- \* Solid Wood Cabinet
- \* Aeroplane Cloth Covered
- \* Tone Control
- \* Heavy Duty 8" Speaker
- Complete with Tubes

**YOUR COST \$37.00**

VMI BRUSH CONTROL MIKE—Net \$10.40  
MM TURNER CONTACT MIKE—Net \$ 9.45

**Phono Amplifier**



3 Tube AC-DC  
Uses: 50L6, 35Z5, 12SR7,  
and 450 ohm speaker  
Net \$5.97

FOR LATEST CATALOG WRITE TO...

**Simon's**  
RADIO SUPPLY  
CHARLESTON, W. VA.

ALL STANDARD LINES CARRIED IN STOCK

# HOW TO PASS Commercial Radio Operators' FCC LICENSE EXAMINATIONS...

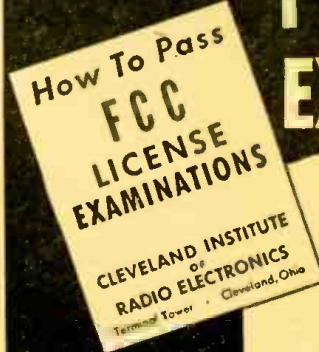

## FREE BOOKLET

**Don't Delay—Write Today!**

**Tells you the Government requirements for all classes of commercial operator licences.**

Tells where to apply for and take the examinations, examining offices, scope of knowledge required, extracts from FCC Rules and Regulations, extracts from FCC Study Guide and Reference Material, approved way to prepare for FCC examinations, positive method of checking your knowledge before taking the examinations.

**EDITION LIMITED—MAIL COUPON BEFORE SUPPLY IS EXHAUSTED**

### CLEVELAND INSTITUTE OF RADIO ELECTRONICS

Contractors to the Canadian Broadcasting Corporation

Successors to

NILSON RADIO SCHOOL, Founded 1939

SMITH PRACTICAL RADIO INSTITUTE, Founded 1934

RC-8 TERMINAL TOWER

CLEVELAND 13, OHIO

APPROVED FOR VETERAN TRAINING UNDER G. I. BILL OF RIGHTS

----- MAIL THIS COUPON -----  
**CLEVELAND INSTITUTE OF RADIO ELECTRONICS**

RC-8 TERMINAL TOWER, Cleveland 13, Ohio

Gentlemen: Please send your FREE Booklet, "How To Pass FCC License Examinations."

(NOTE: This booklet does not cover examinations for Amateur Licenses.)

NAME ..... I have had experience in broadcast-  
ing  servicing  operating   
ADDRESS ..... mfg.  CAA  Army-Navy   
CITY ..... STATE ..... amateur  other .....

Check license desired:

Radiotelephone  1st. Class  2nd Class I am a  High School Grad. College  
Radiotelegraph  1st Class  2nd Class Grad.  with degree .....

I now hold these licenses ..... If a War Veteran, check here





**SERVICEMEN ARE HONEST**

(Continued from page 774)

bill. The additional inspection fee was not considered an objection, and several of the shops which made such a charge were recommended.

Shop A, one of a chain of three, presented an estimate of \$4.75 with all work and repairs covered by a one-year guarantee. Twenty-four-hour service is given when replacement parts are available. No service charge is made at this shop, but \$1.00 is charged as a nominal fee for a service call.

Shop B estimated the cost at \$5.50 for replacing the condenser and realigning the set. A service charge of 50 cents is made if the set must be dismantled for diagnosis, and \$2.00 is asked for a service call. Both of these fees are absorbed if the work is done. All work is guaranteed.

An estimate of \$5.00 to \$6.00 was made by Shop C. This is for replacing the condenser and possible shorted tube. Service calls are made at a slight charge and all work and parts guaranteed.

Shop D determined a charge of approximately \$6.00 for labor and parts with guarantees for ninety days. Service charges from \$1.50 to \$2.50 are made for estimating repairs and costs but are absorbed when the work is done.

Shop E charged \$1.00 service fee plus \$6.10 for parts and labor. All work is guaranteed for ninety days. Service calls are made at a fee of \$1.50.

In contrast to the "survey" conducted by *Reader's Digest* several years ago, the findings of *PM* present a much more accurate picture of the radio servicing field. It should also be noted that as previously stated, the malfunction of the receiver was real and not some wire that had been disconnected purely as a means of testing the serviceman.

Still another noteworthy fact is that the average customer may be sufficiently impressed with the business-like procedure of a serviceman to be willing to pay the additional service charge made by some shops.

School broadcasting in Maryland was foreshadowed last month, when Governor O'Connor disclosed that five locations for frequency-modulated public school stations had been selected.

The chief executive said the projected FM system would be exclusively for school use. "It will permit the transmission of selected educational programs from the major broadcasting systems and on especially prepared subjects.

"While the main purpose at the present time is to present these programs during classroom hours, it is entirely possible that developments may bring about the transmission of educational broadcasts to the people of Maryland at out-of-school hours for home reception," said the Governor.

for everything in Radio

Get **ALLIED'S 1946 RADIO CATALOG**

**FREE** send for it now!



**LARGEST STOCKS OF RADIO AND ELECTRONICS EQUIPMENT**

Get the handiest, most complete Buying Guide in Radio! Packed with the latest, finest values in parts, tubes, test instruments, tools, books, communication receivers, Ham gear, public address equipment... more than 10,000 items of nationally known, guaranteed quality... the world's largest and most complete stocks. For earliest delivery, fastest service, lowest prices, depend on ALLIED! Send for this FREE 1946 Catalog now.

**MORE THAN 10,000 ITEMS**—Largest and most complete selection of radio and electronic equipment to serve the needs of engineers, servicemen, dealers, soundmen, amateurs, and builders. All the leading makes. Guaranteed quality. Lowest prices. Everything you need from one dependable supply source!



**HAM GEAR**

Earliest delivery on latest communication receivers and transmitters. Time payment plan; trade-ins accepted.

**HOME SETS**

Parade of 1946 radios and phonoradios. Handsome styles. Wonderful performance. Today's leading values.

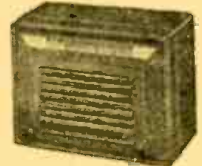

**NEW P. A. EQUIPMENT**—Complete Sound Systems for every public address requirement. All the newest developments. Everything in amplifiers, speakers, microphones, accessories. New intercom systems. Also the latest developments in recording and record-playing mechanisms.

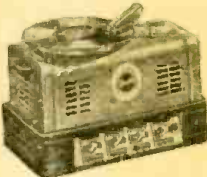

**HANDY RADIO BOOKS**

- Radio Formulas and Data
- Dictionary of Radio Terms
- Radio Circuit Handbook
- Radio Builders' Handbook
- Simplified Radio Servicing
- Radio Data Handbook

ALL SIX BOOKS No. 37-799... 75c

**HELPFUL CALCULATORS**

- These radio reference aids provide valuable data quickly:
- Parallel Resistance and Series Capacitance Calculator. No. 37-960. 25c
- R-F Resonance and Coil Winding Calculator. No. 37-955... 25c

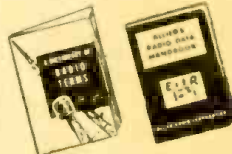

**ALLIED RADIO CORP.**  
833 W. Jackson Blvd., Dept. '2-HH-6  
Chicago 7, Illinois

**FREE**

- Send FREE 1946 RADIO CATALOG
- Send Six Books No. 37-799
- Send Calculator No. 37-960 } \$.....enclosed
- Send Calculator No. 37-955 }

Name.....

Address.....

City.....Zone.....State.....

**ALLIED RADIO**

*Everything in Radio and Electronics*

# FOR ALL Electricians

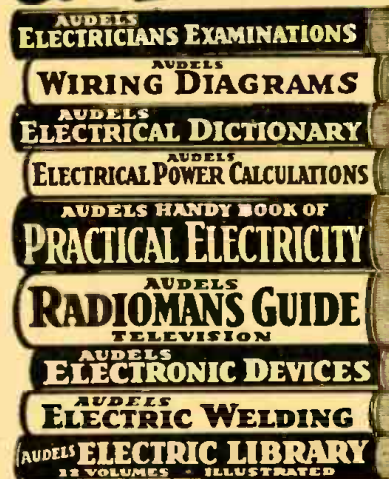

PRACTICAL ELECTRICITY at your finger ends. Answering your Questions and giving the facts and figures of your trade. Audel's Electrical Guides contain Practical Inside Trade Information In a handy form. Fully illustrated and Easy to Understand. Highly Endorsed. Check the books you want for 7 days' Free Examination. Send No Money. Nothing to pay postman. If satisfied pay only \$1 a month until purchase price is paid.

ASK TO SEE THEM.



Get This Information for Yourself. Mail coupon today. No obligation unless O.K.

CUT HERE

## MAIL ORDER

AUDEL, Publishers, 49 W. 23 St., NEW YORK 10, N. Y.  
Please send me postpaid for FREE EXAMINATION books marked (X) below. If I decide to keep them I agree to mail \$1 in 7 Days on each book ordered and further mail \$1 monthly on each book until I have paid price.

- ELECTRICIANS EXAMINATIONS, 250 Pages . . . \$1.
- WIRING DIAGRAMS, 210 Pages . . . . . 1.
- ELECTRICAL DICTIONARY, 9000 Terms . . . . . 2.
- ELECTRICAL POWER CALCULATIONS, 425 Pages. 2.
- MANDY BOOK OF ELECTRICITY, 1340 Pages . . . 4.
- RADIOMAN'S GUIDE, 914 Pages. . . . . 4.
- ELECTRONIC DEVICES, 216 Pages . . . . . 2.
- ELECTRIC WELDING, 400 Pages . . . . . 1.
- ELECTRIC LIBRARY, 12 vol., 7000 Pgs., \$1.50 Each

Name \_\_\_\_\_  
Address \_\_\_\_\_  
Occupation \_\_\_\_\_  
Employed by \_\_\_\_\_ RCP

### DETECTOR TURNS UP LOOT

Mine detectors last month located "treasure" buried in his backyard by a now dead postal employee. The metal locator discovered \$153,000 which had been concealed in two lengths of stove-pipe and buried nine feet deep in a garden.

The money had been secreted by a Jacksonville (Florida) postal worker, who was arrested but became ill and died before being brought to trial. Before his death he confessed to the theft but did not tell where the money was hidden. Although the yard had been thoroughly dug up, postoffice inspectors were convinced he could not have concealed the money far from home. The electronic apparatus was borrowed from the Army and after a half-day's work, turned up the buried loot.

# TRY THIS ONE

### U.H.F. CHOKE FORMS

For some time I had been seeking suitable material for making high frequency choke forms. One day I happened to enter the battery repair department of a railroad shop.

I found that the separators used in signal batteries are polystyrene rods  $\frac{1}{4}$  inch in diameter. These are about 3 inches long and have  $\frac{1}{8}$ -inch holes drilled in each end, which makes it unnecessary to drill any holes for the choke leads.

These rods also make nice spacers for Zepp antenna lead-ins.

When a battery is beyond repair, the separators are discarded and I am sure that they may be had for the asking.

A. C. WILLIAMS,  
Princeton, W. Va.

RADIO-CRAFT wants original kinks from its readers, and will award a seven-month subscription for each one published. To be accepted, ideas must be new and useful. Send your pet shortcut or new idea in today!

### TUBE REPAIRS

Glass tubes frequently come loose from their base. An attempt to use the tubes in this condition will often result in breakage or short circuiting the leads.

Simply wrap two or three turns of  $\frac{1}{2}$ -inch "Scotch" tape around the tube at the junction of the base and the bulb. If the tube is handled carefully, the joint will be firm for the rest of its life.

OTTO WOOLLEY,  
Colorado Springs, Colo.

### HEAVY WIRE LUG

It is often difficult to attach heavy stranded wire to any device that is equipped with small screw terminals.

This task is made easier and more substantial by filling the end of the wire with molten solder and allowing it to cool. The end is then pounded flat and drilled to pass the screw. The screw is run through the wire and into the terminal block to make a semi-permanent fastening.

THEODORE A. BYLES,  
Chicago, Ill.

### P.A. KINK

In some public address applications it is found necessary to feed a speaker from the voice-coil winding of an amplifier's output transformer at some times, and from a 500-ohm line at others.

A double-pole double-throw switch mounted in the speaker case is a great convenience in such cases. The speaker can be adapted to either line or low-impedance output winding immediately.

EDWIN COOPER,  
Independence, Kansas

### SERVICEMAN'S COMPASS

Here is a handy device to use when checking a receiver by substituting parts to find if any are defective.

It is a compass-like device made of  $\frac{1}{4}$ -inch hardwood. Two screw-type binding posts are mounted on the body, and wires are run down metal-tipped legs.

Resistors, condensers or coils may be tied to the binding posts and the brass legs are touched to the two points in the circuit where the part is to be inserted. By connecting headphones and a blocking condenser across the binding posts, the device may be used as an audio signal tracer.

The movable legs make the device easy to adjust to reach the desired contact points. Although I used hardwood for my tester, plastic, bakelite or similar insulating material may be used.

EMANUEL F. COX,  
Caraway, Ark.

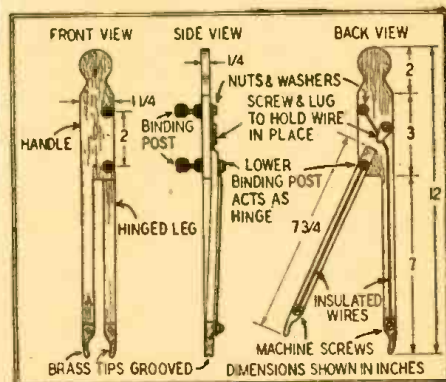

### SPEAKER Baffle

In looking around for a suitable baffle for a newly constructed phono amplifier, I hit upon the idea of using the cabinet of an old Victrola. As you know, these have a large sound chamber leading down from the base of the old style pickup to grill in the front.

I removed the pickup and mounted a 3-inch speaker over the hole leading to the sound chamber. Connecting this speaker to the phono amplifier, I found the tone quality to be good.

The amplifier may be mounted below the motor panel and holes drilled for the controls.

This "kink" may be used on any old phonograph having a large sound chamber.

FORREST J. DASSEL,  
Elberfeld, Indiana

(Certain of the old de luxe phonograph cabinets were much better and more heavily built than modern radio cabinets. When used as speaker housings, cabinet resonance is at a minimum. One type used the orthophonic horn, which may be sawed off at the proper point to mount a small speaker. Editor)

## WHY NO "POSTWAR" RADIOS?

(Continued from page 745)

This manufacturer started to develop a radically new radio set early in 1945. This particular receiver has no chassis, it has practically no wiring of any kind, it has no tube sockets as used in ordinary sets, it has no resistors as we know them today; instead the resistors are printed with a special carbon ink. It requires but little assembling. A few basic units are riveted together which almost assembles the set, with the exception of the loud speaker. This receiver weighs much less than similar ones, is cheaper to make, and will revolutionize servicing, as there are no soldered connections and no wires.

We inspected one of the models which was excellent and worked well. The manufacturer spent a young fortune in developing and tooling up, but had to abandon the entire project in early 1946. He just could not buy some of the necessary components such as loud speakers, variable condensers, and—most important—the tubes.

No component or tube manufacturer could or would take even a modest order, as they had their old customers who were clamoring for materials, parts or components. These old-line customers naturally had to be supplied first—newcomers who had recently established themselves would have to wait.

That is the economic procedure today. So the revolutionary radio set manufacturer had to quit cold and wait for another day, which may come in 1947 or 1948—if he is lucky.

Other enterprising new manufacturers and even old set manufacturers had to quit launching new types of sets for the same reasons.

From this it is obvious that you will not be able immediately, or for some time, to buy postwar sets with the latest radio war engineering principles incorporated in them.

For that reason the advice is: Buy the sets at present available. They will be the only ones obtainable and you also know that they are not experiments and will give a maximum of service.

## tone control circuits

(Continued from page 763)

after a resistance-coupled plate circuit, a large blocking condenser (0.1  $\mu$ f) should be inserted following the plate

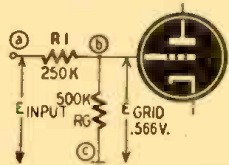

Fig. 6—A little circuit theory is harmless.

resistor, to keep plate voltage off the grids of the tone control tubes. No grid leak resistors are needed, as they are provided for in all these circuits.

## HARRISON HAS IT!

\* HSS

**24G TUBES** (3C24/VT204) An FB triode for VHF, 90 Watt, rated Class C output, 6.3 Volt, 3 amp filament. Small bulb. Made by H & K, Gov't. inspected, fully guaranteed! Regular amateur net price was \$9.00, reduced to \$6.00, Harrison sells them in lots of 3 or more for only **\$1.48** each

(Less than 3, at \$1.69 each)

The last time we offered these popular tubes, orders and reorders came in so heavy, we had to ration them. But this time, we think we have plenty—so order as many as you want—spares—presents, etc.!

### BC-406 15 TUBE UHF RECEIVERS

Been getting such FB reports from our customers about these swell Signal Corps Radar receivers that we just had to get more for you.

Six acorn tube RF circuit, tuned to 205 MC; four IF stages; Thordarson heavy duty power transformer delivering 350 volts at 145 MA; four choke and oil condenser filter; 115 volt 60 cycle operation; chassis 10 1/2" x 25 1/2", in metal case, slightly used but fully guaranteed.

Complete with tubes; 5-954, 1-955, 4-6SK7, 2-6S17, 2-6N7, J-5T4.

Instructions and diagrams for easy conversion to a hot 10 (also 6 and 2) meter superbet receiver are included. The parts alone are worth **\$21.98** much more than our low HSS Price

**BC-406-A** Some, but also has an 11 Watt 2/3 RPM 110 Volt motor, 1-68N7GT, and 1-68P5 (omits 1-6N7). **\$29.75** Like new!

**PRECISION RESISTORS**, 1 Megohm, 1 watt, 1% accuracy, IRC WWV. Use as a thousand volt multiplier with 1 ma meter. List Price \$5.25. HSS in lots of THREE at 98c each. (Less than three—\$1.19 each.)

3CA938-A Acorn Tubes, New standard, boxed stock. Reg. net price \$6.95.

HSS **\$1.90**

Linen lacing cord, 1 lb. spool **\$2.25**

### HSS OIL CONDENSERS

G.E. 4 mid 600 Volt, Rectangular case with standoff insulators. **THREE for \$3.47**

Round metal case, single hole mount, 2 Mfd. 1000 Volt **FOUR for \$2.34**

Bathtub type, 2"x2"x1 1/4" 2 Mfd. 600 Volt **FOUR for \$2.12**

### LONG WAVE RECEIVERS

Navy Model RAK-7, New, in original crates. A real commercial job for marine, aviation, etc., use. 15 to 600 KC. Two tuned RF stages. Band switching, precision dial, AVC noise limiter, Band pass filter, tunable audio filter, Db output meter, filament voltmeter. Six tubes plus three in 115 Volt, 60 cycle regulated power supply. Complete with tubes and instruction manual **\$64.50**

Steel chest 12" x 12" x 18" containing 50 pounds of spare parts—transformers, chokes, condensers, sockets, coils, switches, etc. All new, with specifications! **\$12.00.**

### DYNAMOTORS

Just the thing for that mobile amplifier, Xmitter, etc! 12 volt input gives 680 volts at 210 ma; 6 volt input delivers 300 volts at 210 ma, or 265 volts at 300 ma. Compact, well-constructed unit for Military use. Weighs only 6 1/2 lbs, with mounting. Ball bearings for good efficiency. Brand new, **\$8.95** HSS Special!

### ANTENNA TUNING UNIT

Signal Corps Model BC-939-A. Designed to efficiently couple the HT-4E (or almost any transmitter up to 1 kW) to any short or long wire antenna. Has three rotary coils with cyclometer crank tuning. Isolation switches. RF ammeter, in black metal cabinet. Covers 2 to 18 MC with proper plug-in vacuum condensers, available separately. Brand new! **\$32.50** HSS

22 mfd condenser to cover 10 to 18 MC **\$9.75**

50 mfd condenser to cover 2 to 10 MC for almost any frequency on long antenna **\$11.50**

### \* Harrison Select Surplus

Your assurance of good, usable, guaranteed, surplus material at sensationally low prices—top value all ways! Come in and browse through our large, entirely separate HSS Department (Harrison Select Surplus).

## HARRISON HAS IT!

\*\*ALL STANDARD LINES

### RECEIVERS

As one of the world's largest distributors of Communications Equipment, we are delivering plenty of receivers—right now! All makes—practically all models.

If you want your new set in the quickest possible time—send your order to HARRISON!

**NATIONAL**  
11RO-5TA-1, New model with noise limiter metal tubes, ham bandspread coils. Complete with Pak, speaker, and coils 1.7 to 30 Mc. **\$303.00**  
NC-240-C **225.00**  
NC-46, AC-DC Receiver **97.50**

**HAMMARLUND**  
New Super Pro SFC-400 SX, 1.25 to 40 Mc. **310.05**  
HQ-129-X, With speaker **168.00**

**HALLICRAFTERS**  
FM-AM CW. Peak performance on 10 and 8 meters, a swell police job, a beautiful high-fidelity receiver (old and new bands), an excellent piece of Lab equipment—all in one! Acorn tube RF section, noise limiter, 15 tubes, 27.8 to 143 Mc. Model 8 36-A, \$415.00, reduced to only **\$307.50**  
S-41 Sky Rider, Jr. **39.50**  
S-38 New Sky Buddy **79.50**  
S-40 1946 Sky Champion **223.00**  
S-X-28-A Super Sky Rider **39.50**  
RME 45, New, revised model with calibrated ham bandspread. With speaker **186.00**  
RME 84, New eight tube receiver. Complete **98.70**

Literature on any receiver gladly sent upon request. Write today! (All prices subject to change without notice.)

### ELECTRIC DRILLS

Thor—one of the best quality makes. Compact, sturdy, a good lifetime tool. Jacobs chuck. 1/4", 2500 RPM free. Model U14AP **\$32.50**  
1 1/2", 500 RPM, with removable dood handle for extra leverage on heavy jobs. Model U14 **\$9.50**

Our TOOL DEPT. also has pliers, cutters, soldering irons, steel work benches, screw drivers, etc.—in stock!

### INTERCOMMUNICATION SYSTEMS

Talk-A-Phone LP-5-Master for up to five remote stations. **\$19.95**  
R8-3 Remotes (can call master) **\$7.25**  
LP-110, For ten station multiple master system. **\$26.50**  
BOOPN 12-C, For up to 12 station multiple master system. (Many other models in stock.)

This space is reserved for all the new items announced by the manufacturers in their ads in this magazine. Send us your orders, NOW, because just as soon as it is available—

## HARRISON HAS IT!

### DUMONT OSCILLOGRAPH

Model 208-B, An excellent 5" scope for Lab. Service Bench, or Ham Shack! **235.00**  
Our TEST EQUIPMENT DEPT. can furnish practically all makes and models of instruments, with many in stock for immediate shipment. Send in your orders NOW for best delivery!

\*\* We are

### FACTORY AUTHORIZED DISTRIBUTORS

for the top quality manufacturers and we now have in stock lots more new, latest improved production Ham gear! Visit our stores today, for everything you need. We promise you fresh, clean material—quicker—at the lowest current prices—and, above all, our sincere desire to be of friendly, helpful service.

**MAIL ORDERS?**—Certainly! Just list everything you want (items in this ad, or any ad, magazine or catalog) and include deposit.

73 de

Bill Harrison, W2AVA



## HARRISON RADIO CORPORATION

12 WEST BROADWAY • NEW YORK CITY 7  
BARCLAY 7-9854

JAMAICA BRANCH — 172-31 Hillside Ave. — REPUBLIC 9-4102

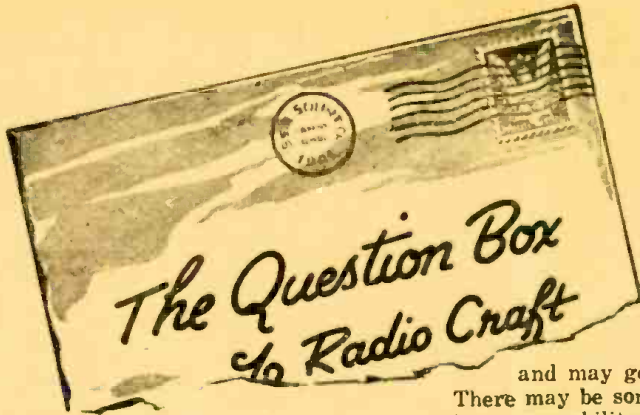

The Question Box is again undertaking to answer a limited number of questions. Queries will be answered by mail and those of general interest will be printed in the magazine. A fee of 50c will be charged for simple questions requiring no schematics. Write for estimate on such questions as may require diagrams or considerable research.

### SHORT-WAVE CONVERTER

Some years ago one of your publications printed a diagram of a short wave converter using a single 6K8 tube.

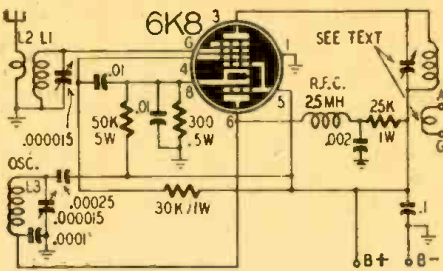

Coils are wound with No. 18 enamelled wire, 1/2-inch diameter, self supporting. For 10 meters, L1 and L3, 16 turns; for 5 meters L1 and L3, 7 turns. L2 is 5 turns in each case.

I cannot find this copy and would like for you to reprint this diagram.—I.H.L., New York, N. Y.

A. Here is a converter diagram that appeared in the November 1940 issue of *Radio and Television*. This converter was designed for operation on the 5 and 10 meter bands. Output coil is 34 turns of No. 30 enamel wound on an i.f. dowel, with coil AG, 10 turns, wound over it. The output of the converter is connected to the antenna and ground posts of a receiver tuned to 2500 kc.

### PERMEABILITY TUNER

Will you please print a diagram for a three-tube permeability tuner using a 12SA7 oscillator.—J.V., Hollywood, Calif.

A. A permeability tuner circuit is shown. The antenna and oscillator coils are ganged to operate with a single tuning control. The values of the trimmer condensers will depend upon the coils

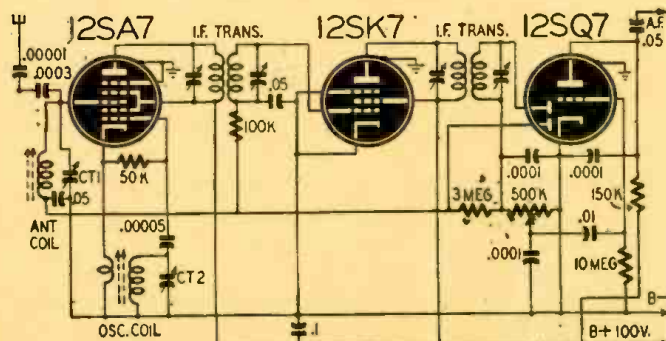

A=SMALL ANT. PLATE; ANT. AND OSC. PERMEABILITY TUNING COILS GANGED.

and may go as high as 300  $\mu$ f. There may be some difficulty in obtaining permeability-tuned units, but apparently you have one at hand. Any standard power supply with voltages near 100 and 250 may be used.

to the grid return side of the secondary of L3. The lead from prong No. 4 of the 7E7 is connected to the grid return of L3. This connection should be omitted as it shorts the a.f. to ground through C9.

The Super-Reflex as equipped for two-band operation. Commercial coils are used to simplify winding problems.

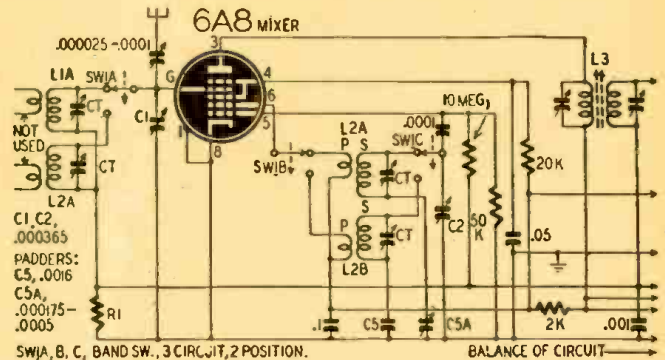

### S-W ON SUPER-REFLEX

I am interested in adding a short wave band to the Super-Reflex Radio that was described in the March issue of *RADIO-CRAFT*. Kindly print a diagram showing how short wave coil and switch may be added to the oscillator-mixer circuit of this set, if such a circuit is practical.—J.R.K., Joliet, Ill.

A. Here is the diagram that you requested. The short wave coils are purchased to cover the desired range with a 456 kc intermediate frequency. The padder condenser values will differ with various makes of coils and should be those recommended by the oscillator coil manufacturer.

The reader's attention is called to two errors that appeared in the original drawing of the Super-Reflex Radio. The resistor R5 is shown connected to the primary of L3. It should be connected

### BURGLAR ALARM

Please print a burglar alarm that operates when a light ray is broken. Alarm should ring a few minutes.—A.S.N., Vancouver, Canada.

A. This circuit should meet your specifications.

When the light rays to the CE-1 phototube are interrupted, the bias is removed from the 2051, causing it to conduct current and close relay A. This charges the condenser in the grid circuit of the 117L7, biasing it to cut-off and allowing relay B to open, thus closing the alarm circuit. This relay will remain open until the voltage on the condenser has leaked off through the 20-megohm resistor. The tube will then again draw current, the relay will open the alarm circuit. The length of time the alarm rings may be altered by changing the values of the resistors and condenser in the grid of the 117L7.

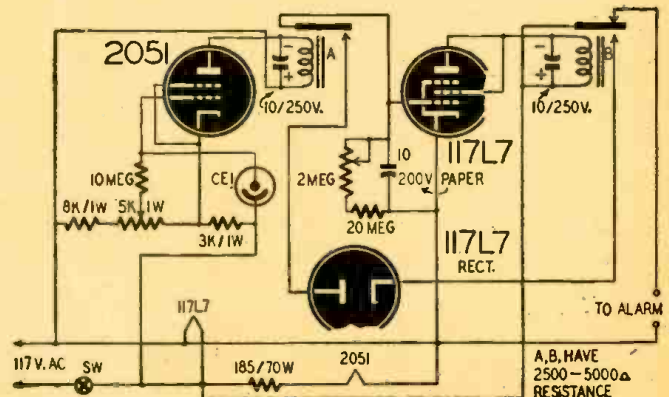

**ARMY SIGNAL ASSOCIATION**  
(Continued from page 748)

**ASSOCIATION MEMBERSHIP**

The Association is non-profit making and membership is open to present and former members of the Armed Forces and civilians who are American citizens, and to all firms, companies, associations, and groups controlled by American citizens.

The provisional Constitution and By-Laws provide for the following classes of membership and dues:

- a. Life Membership—\$50.00.
- b. Full Membership—\$4.00 annually.
- c. Group Membership—\$100.00 annually. Open to all firms, companies, and associations interested in promoting the cause of industrial preparedness, particularly in connection with research, development, operation, production, manufacture and supply of communication, electronic, motion picture and photographic equipment. Group members have the privilege of nominating five (5) of their officials or employees who are American citizens to be full members in the Association without dues. For each member in excess of five (5) nominated by a group member, the annual dues are \$4.00.
- d. Student Membership—\$2.00 annually. Open to all men and women who are students in technical courses in schools and colleges.

Members are entitled to the official publication of the Association, which will be published bi-monthly, and to such other publications as may be issued periodically.

It is planned to organize local chapters throughout the United States at places where there is a group large enough to organize and maintain such a chapter.

The Constitution will be subject to the approval of the membership and the officers and directors will be elected by letter ballot. To get the organization under way, I have appointed provisional officers and a provisional board of directors who will serve only until the first election can be held.

These interim officers are:

**President—**

David Sarnoff, President of Radio Corporation of America.

**Vice-Presidents—**

William J. Halligan, President, The Hallicrafters Company.

Darryl F. Zanuck, Vice-President, Twentieth Century-Fox Film Corporation.

Master Sergeant Fred Friendly, an expert on Aircraft Warning Equipment.

**Directors—**

Carrol O. Bickelhaupt, Vice-President and Secretary, American Telephone and Telegraph Company.

Thomas A. Rivere, former Master Sergeant of detachment which set up communications at the Quebec, Yalta and Potsdam Conferences.

George P. Dixon, Vice-President, In-

**GET THIS  
NEW BOOK  
FREE**

**Just for  
Examining this  
New 1946 Electrical  
TROUBLE  
SHOOTING  
MANUAL**



Sensational new 612-page Coyne "Electrical and Radio Trouble Shooting Manual." 500 shop prints and "how to use them"—plus many other practical features—all in one giant 8½" x 11" handsomely bound volume. New time saving, easy-to-follow methods of shooting trouble. Includes D. C. and A. C. Motors, Armatures, Switchboards, Electronic Controls, Radio Receivers, Auto Ignition, Refrigeration and Air Conditioning, etc. Most amazing book of its kind ever published. You get it FREE for 10 day trial plus the new book "Starting and Operating a Profitable Electrical or Radio Shop" as our outright gift to you. Rush coupon today for this amazing offer.

**... FREE with  
TROUBLE SHOOTING MANUAL**

Act now and I'll include 1 full year of personal counsel from the Coyne Staff—technical advice by mail on any Electrical or Radio problem. A real help in your daily work.

**ALSO FREE:** 1 year subscription to Coyne Technical News—latest facts on Electrical and Radio Progress, illustrated and explained.

**COYNE ELECTRICAL SCHOOL**  
500 SOUTH PAULINA ST.  
DEPT. CS-72 CHICAGO, ILL.



**SEND NO MONEY**

Yes, that's right! You get Coyne's sensational new book "Starting and Operating an Electrical or Radio Shop" FREE—HERE'S MY OFFER—Mail the coupon below—and I'll rush you a copy of 1946 edition of Coyne's "Electrical and Radio Trouble Shooting Manual" for 10 days free trial—plus FREE copy of my "Starting a Shop" book. Examine the "Trouble Shooting Manual" 10 days, then DECIDE. IF NOT 100% pleased return the manual and owe nothing—if you keep it, pay according to terms in coupon below. But REMEMBER, whether you keep the Coyne "Electrical and Radio Trouble Shooting Manual"—or return it—the "Starting and Operating an Electrical or Radio Shop" book is yours to keep FREE.

**10 DAYS' FREE TRIAL**

"Starting and Operating a Profitable Electrical or Radio Shop" tells you how to start full or part time Electrical or Radio Shop on small capital. Explains how to finance, choose a location, how and what to buy, advertising, salesmanship, business and legal angles, record keeping. For a Limited Time this amazing new book is given absolutely FREE... just for examining the sensational new 1946 edition of Coyne's "Electrical and Radio Trouble Shooting Manual" 10 days at our expense. ACT NOW—mail the 10 days' FREE TRIAL coupon today!

**MAIL COUPON FOR FREE BOOK**

I, C. LEWIS, President, COYNE ELECTRICAL SCHOOL, Dept. CS-72 60 South Paulina Street, Chicago 12, Illinois O.K.—send me your new Coyne Electrical and Radio Trouble Shooting Manual, postpaid along with my FREE COPY of "Starting and Operating a Profitable Electrical or Radio Shop." Within 10 days after the date some I'll either return the "Trouble Shooting Manual" to you and OWE NOTHING or send \$3.00 and \$3.00 a month until a total of \$9.00 is paid. Either way I keep the "Starting and Operating an Electrical or Radio Shop" book as my free gift.

Name \_\_\_\_\_  
Address \_\_\_\_\_  
Town \_\_\_\_\_ Zone \_\_\_\_\_ State \_\_\_\_\_  
Occupation \_\_\_\_\_  
**SAVE 10%** Send cash price, \$9.00—you save over 10%. Same 10-day free trial and MONEY BACK SATISFACTION GUARANTEE.

ternational Telephone and Telegraph Company.

Harry J. La Brum, member of prominent Philadelphia law firm.

W. H. Hitchcock, Chief Engineer, Southern California Telephone Company.

Paul V. Galvin, President, Galvin Manufacturing Corporation.

William C. Henry, President, Northern Ohio Telephone Company, and President of the U. S. Independent Telephone Association.

Theodore S. Gary, Vice-President Theodore Gary & Company, and Vice-President, Automatic Electric Company

Dr. Harold A. Zahl, Assistant director

for Engineering Research, Signal Corps Engineering Laboratories.

Fred R. Lack, Vice-President and Director of Radio Division, Western Electric Company.

The interim Executive Secretary of the Association is Stephen H. Sherrill, Brigadier General, U. S. A., retired, and the present headquarters is located at 631 Pennsylvania Avenue, N. W., Washington 4, D. C.

While the Armed Forces will maintain a vigorous interest in the Association, its growth and importance will depend mainly upon civilians to whom its management will be intrusted. I am sure they will do a thorough job.

# NEW RADIO-ELECTRONIC PATENTS

Edited by I. QUEEN

## UHF MODULATION SYSTEM

Walter Van Roberts, Princeton, N. J.  
Patent No. 2,393,414

**UHF WORKERS** are well aware that at very high frequencies it becomes more difficult to secure amplitude modulation without simultaneous frequency modulation. In some cases the latter is not detrimental to communication, except that as the proportion of FM increases, a smaller proportion of AM is effective. In the microwave region, the FM may form an appreciable portion of the total modulation.

To overcome the difficulty, this invention makes use of a wave guide. It is known that any given wave guide has a sharp cut-off at some frequency which is related to its physical dimensions. As the critical frequency is approached, the attenuation rises rapidly.



The wave guide is used between the generator and radiator, its dimensions being such that it operates almost at cut-off. As an example, such a guide operating at about 500 mc might consist of a pipe 15 inches in diameter extending to a height of several hundred feet. The upper end would terminate in a horn radiator and the lower in the u.h.f. generator.

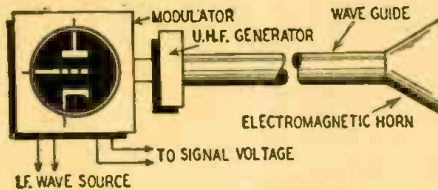

In the microwave region, modulation generally consists of a relatively low r.f. (or intermediate frequency), which, in turn, is modulated by an a.f. When such modulation is applied, the carrier is shifted. When it moves in the direction of cut-off, the wave guide attenuation rises, and vice versa, thus effectively amplitude-modulating the carrier as its frequency varies. Thus otherwise undesirable frequency modulation of the transmitted wave is transformed into and made to reinforce the amplitude modulation applied to the carrier.

An equivalent system may be utilized where a receiving system is to receive an FM transmission. The latter does not appreciably affect a crystal detector, but a wave guide may be incorporated as shown. The FM carrier becomes essentially amplitude modulated as by the attenuation effect of the wave guide, and may therefore be detected.

## TUBE TESTER

James B. Crawley, Edenton, N. C.  
Patent No. 2,399,859

**COMMON** types of tube testers measure emission or mutual conductance. While much in-

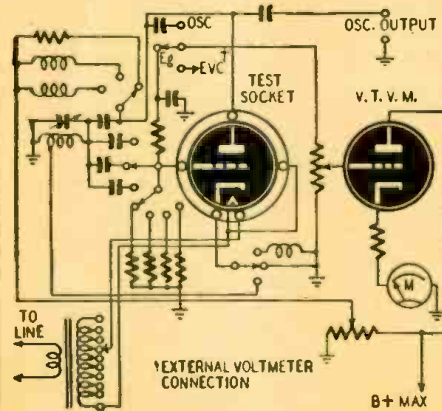

formation about the tube is given, these types cannot indicate the quality of the tube as an oscillator.

The accompanying schematic illustrates a versatile circuit in which the tested tube is operated under actual oscillator circuit conditions. The filament is connected to a tapped transformer secondary. The B supply is tapped for various plate potentials. The grid and cathode of the tube is connected to the desired value of components as shown. Shunt feed is used, a resistor or suitable coils being switched in for connection to the plate. Note that the oscillator output is available as a generator signal for other purposes.

A VTVM tube is added so that the efficiency of the oscillator tube can be measured under the several conditions. The voltmeter may be connected either to the oscillator plate (through a condenser), or to the grid (through a resistor) or to an external voltage.

## TORSIOGRAPH

Lawrence F. Hope, Grosse Pointe Farms, Mich.  
Patent No. 2,399,635

**MANY** types of machines require torsional vibration study, so that methods may be devised to eliminate non-uniform rotation of a shaft. This invention offers means of measuring and indicating the vibration present. It does not require direct access to the vibrating shaft.

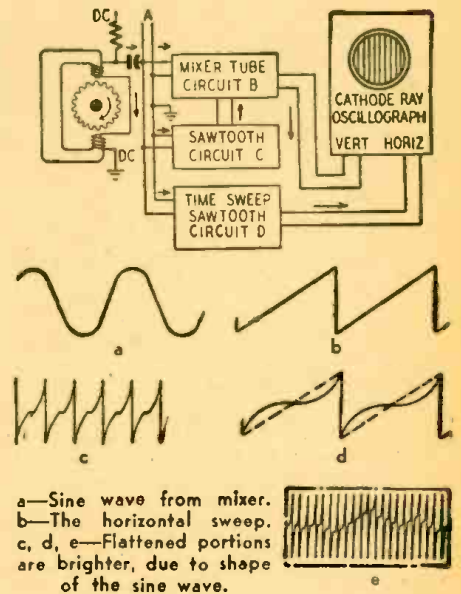

a—Sine wave from mixer.  
b—The horizontal sweep.  
c, d, e—Flattened portions are brighter, due to shape of the sine wave.

A thin toothed wheel is mounted on the shaft and an electromagnet mounted with its poles close to the wheel. The magnet coils are supplied with direct current. As the teeth move between the poles, an alternating voltage is induced in the windings and is present across wires A. The voltage actuates two sawtooth circuits, C and D. The output of C combines with the induced voltage (in the mixer circuit B) and the result appears across the oscillograph vertical posts. The induced voltage may be taken as approximately a sine wave due to tooth shaping. The output of D is connected across the oscillograph horizontal binding posts. Its frequency may be a sub-multiple of C.

Combination of sine and sawtooth (c) has a flattened central portion (d). This point is at the horizontal part of the sine wave, so the ray dwells on it longer than any other part of the trace, making a bright spot. As the wave is compressed (e) relative brightness increases.

If the shaft vibrates during rotation, the center of each wave will lag or lead the average value and will therefore appear either earlier or later. This means that it will be either lower or higher than normal and can be distinguished easily. This superimposed wave indicates the torsional vibration.

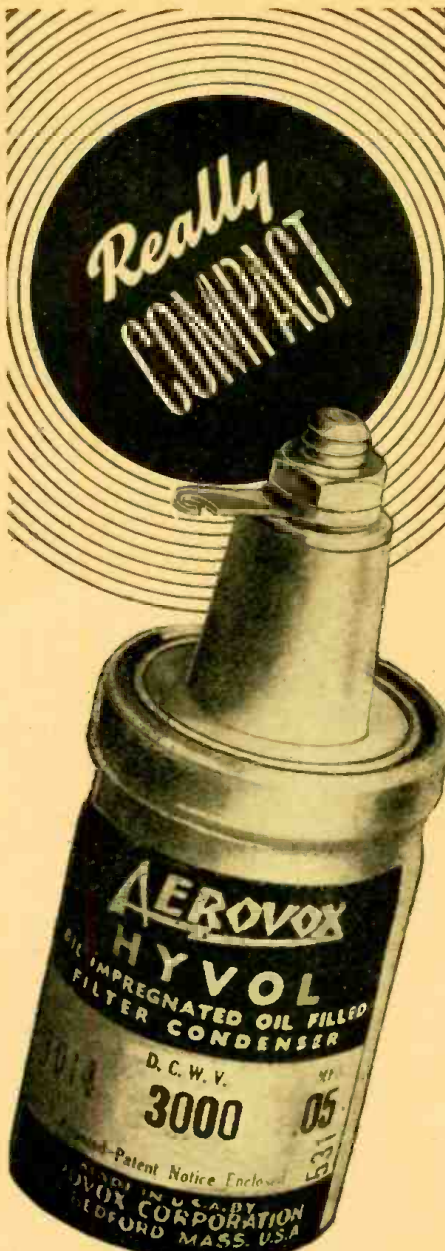

● That's the story. Aerovox Series "14" oil-filled capacitors are only 1 3/4" in diameter by 2 1/4 or 2 3/4" high. 3000 v. .01, .05 and .1 mfd. Unit here shown actual size. And that's compactness for your ultra-compact "rigs." ● Ask your Aerovox jobber for these compact oil capacitors. Ask for latest catalog—or write us direct. ● Meanwhile, be sure to look for the yellow-label capacitors!



**FOR RADIO-ELECTRONIC AND INDUSTRIAL APPLICATIONS**

AEROVOX CORP., NEW BEDFORD, MASS., U.S.A.  
Export: 13 E. 40th St., New York 16, N.Y. • Cable: 'ARLAB'  
In Canada: AEROVOX CANADA LTD., Hamilton, Ont.

**For the Man Who Takes Pride in His Work**

**FM and Television Band Coverage on Strong Harmonics.  
Strong Fundamentals to 50 mc.**

Another member of the Triplett Square Line of matched units this signal generator embodies features normally found only in "custom priced" laboratory models.

**FREQUENCY COVERAGE**—Continuous and overlapping 75 KC to 50 MC. Six bands. All fundamentals. **TURRETTYPE COIL ASSEMBLY**—Six-position turret type coil switching with complete shielding. Coil assembly rotates inside a copper-plated steel shield. **ATTENUATION**—Individually shielded and adjustable, by fine and coarse controls, to zero for all practical purposes. **STABILITY**—Greatly increased by use of air trimmer capacitors, electron coupled oscillator circuit and permeability adjusted coils. **INTERNAL MODULATION**—Approximately 30% at 400 cycles. **POWER SUPPLY**—115 volts, 50-60 cycles A.C. Voltage regulated for increased oscillator stability.

**CASE**—Heavy metal with tan and brown hammered enamel finish. There are many other features in this beautiful model of equal interest to the man who takes pride in his work.

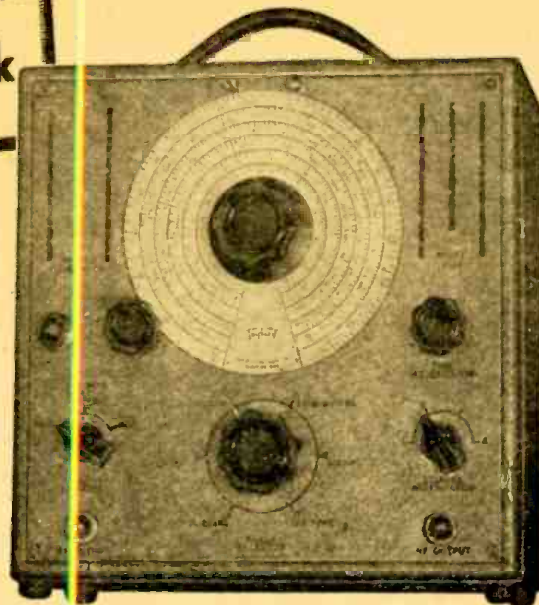

MODEL 2432  
SIGNAL GENERATOR

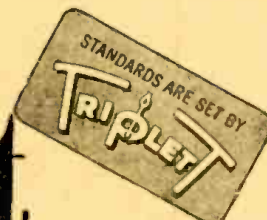

*Precision first  
...to last*

# Triplett

**ELECTRICAL INSTRUMENT CO. BLUFFTON, OHIO**

## RHS SPECIALS

**HIGH VOLTAGE TRANSFORMER**  
AMERTRAN: 60 cycle, 105-115 v.  
PRI, 6200 v. Sec-CT-700 mils. Super  
Special ..... \$39.95

**OIL CONDENSERS: Aerovox C.O., G.E., etc.**

5 Mfd. 50v.....	.49	12 Mfd. 1000v.....	2.59
2 Mfd. 600v.....	.80	5 Mfd. 2000v.....	2.10
4 Mfd. 800v.....	.75	1 Mfd. 2000v.....	.95
6 Mfd. 600v.....	.80	2 Mfd. 2000v.....	2.15
8 Mfd. 600v.....	1.10	4 Mfd. 2000v.....	3.95
4 Mfd. 1000v.....	1.10	10 Mfd. 2000v.....	4.36
8 Mfd. 1000v.....	2.00	1 Mfd. 3000v.....	3.96
10 Mfd. 1000v.....	2.35	1 Mfd. 7500v.....	4.50

**OSCILLOSCOPE KIT**

5CP1—Cathode Ray Tube.....	each	6.95
Socket for Cathode Ray Tube.....		1.98
Anode Button for Cathode Ray Tube.....		.35
Cathode Ray Tube Shield.....		1.49
2x2 Tube.....		1.25
Socket for 2x2 Tube.....		.25
Plate Cap for 2x2 Tube.....		.20
Transformer 1200 v., 2.5, 6.3 v., 110 v., 60 cyc.....		6.50
11V Condenser 5 - 2000 v.....		2.10
Order separate or COMPLETE KIT		16.95

**SPECIAL AT**

**RESISTOR KIT**  
100 Ass'd. Resistors, Popular Sizes. **3.95**  
Extra fine quality.

50 Ass'd. CERAMIC & MICA CONDENSERS. Popular ass't. **3.95**

**10 Ass'd. Popular OIL CONDENSERS BATH TUB Styles. 2.29**

866-99c	6AG7—\$ 1.25	5CP1	\$6.95
6C4-75c	6AK5— 1.60	100TS	3.50
6AL5-60c	6AC7— .95c	1N21	.69c
VR150-75c	257B— 15.00	68L7	1.00
RCA 813	Extra Special		\$9.95

**100 W DUMMY ANTENNA LOAD FOR 80 METERS**  
Complete with Calibration Chart and Manual.  
Steel case..... **3.25**

**POWER SUPPLY FOR MARK 1-11-111 OR OTHER EQUIPMENT**  
12 Amps—12 v. D.C. from 110 v. A.C. Unnecessary to tear set apart. Leave set Portable  
COMPLETE READY TO PLUG IN... **32.50**

**RADIO HAM SHACK, Inc.**

63 DEY STREET NEW YORK 7, N. Y.  
Phone Bo. 9-6875

## SPRAYED-ON CAPACITORS

Condensers made by spraying a thin metal film on the paper dielectric, instead of the usual method of interleaving metal foil between two layers of paper, were successfully made by the Germans during the late war. The Department of Commerce has imported and placed on display one of the machines used in the process.

Several years ago the Robert Bosch Company of Stuttgart, Germany, undertook development of fixed paper condensers in which the usual metal foil is replaced by a very thin, vaporized zinc coating, applied directly onto the paper dielectric. Machines were developed to make the new product, and more than 50,000,000 condensers were turned out by the Bosch company during the war.

One great advantage of this type of condenser is that it *heals automatically* after an electrical breakdown, so that an adequate insulating margin is again established. Numerous breakdowns may occur before the effective value of the condenser is reduced below the workable limit. Because of this, metallized paper capacitors may be operated at from 20 to 50 percent higher voltages than paper and foil capacitors.

The metallized paper capacitors are about 40 percent smaller than the paper and foil type, and it is believed that production costs will be about 20 percent less.

## BUILT-IN QUALITY

Made Our Famous  
**RADIO & PHONO KITS**  
A National Success!

**IDEAL FOR USE BY**  
STUDENTS • SCHOOLS  
• HOSPITALS  
• SERVICEMEN  
• AMATEURS

Our model S-5 uses the universally accepted superheterodyne circuit containing the following tubes: 12SA7, 12SK7, 12SQ7, 50L6, 35Z5 and tubes from 550 kc. to 1600 kc. Model S-5 (Illustrated) — Complete Kit, including

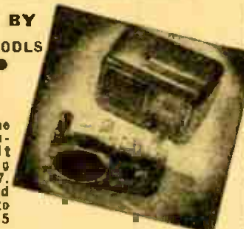

tubes. Bakelite cabinet and four pages of diagrams and instructions **\$19.95**



*Build Your Own*  
**PORTABLE PHONOGRAPH**

Ready for assembly! Beautiful carrying case, pick-up, 2-tube amplifier, volume control.

Complete Kit including tubes... **\$23.95**

**SPECIALS FOR THIS MONTH!**  
5" PM SPEAKER ALNICO V ..... **1.40** each

**All Kits Are Furnished Complete, Less Wire and Solder**

Direct Shipments to All Parts of the World  
25% Deposit on C.O.D. Orders  
Write for FREE Catalog

**RADIO KITS COMPANY**  
Dept. M 120 Cedar St. New York 6, N. Y.

# MONEY-SAVING SPECIALS

Just a few items selected at random from our tremendous stocks. Order direct from this ad and save time. If you don't see just what you want, write for our latest bulletin of money-saving specials.

## Meter and Tester Bargains

M1—G.E. 0-10 A.C. Voltmeter 3/4" Rectangular	\$ 3.94
M2—McLintock 0-300 D.C. Milliammeter 3/4" Rect.	3.93
M3—McLintock 0-500 D.C. Milliammeter 3/4" Rect.	3.93
M4—McLintock 0.15-150-300 D.C. Milliammeter 3/4" Rect.	6.90
M5—G.E. 0-1 R.F. Meter 2 1/2" Diameter	4.92
M6—Marion 0-1 Standing Wave Meter 3/4" Round	3.93
PB-100—Superior Volt-Ohm-Milliammeter	28.40
PB-210—Superior Volt Ohm Milliammeter	35.75
M-400—Superior Vacuum-Tube Voltmeter	52.50
W-665—Weston Selective Analyzer	58.50
F-TS2—Feller Signal Tracing Analyzer	29.50
CA-11—Superior Signal Tracer	18.75
F-1—Feller Signal Tracer	9.85

## Wire and Cable

HP1—Hookup and Pushback Wire, 100' hanks, each	.89
Hookup and Pushback Wire 10 hanks assorted colors	7.80
HP2—Hookup Wire Odd lengths 2 lb. pkg.	1.39
EN3—Enamelled wire No. 26-28-30-lb. spools, No. 22-24 1/4 lb. spools	.89
CC4—D. Cotton covered enamelled wire No. 16, per lb.	.79
SC1—Single Shielded for phono pickups, etc. 100'	2.49
SC2—Single Cond. Shielded wire 100'	3.49
MC1—Microphone cable—shielded rubber covered, odd lengths 6 to 40', per foot	.05
MC50—Microphone Cable—50' lengths, \$2.95—100 feet	5.75
MC2—Microphone Cable—2 Cond. Rubber covered, odd lengths 6 to 40', per foot	.08
MC250—Microphone Cable—2 Cond. 50' lengths 100' lengths	8.75
MC4—4 Cond. Shielded Rubber cov. cable, 100 ft.	10.95
MC8—8 Cond. Shielded Rubber cov. cable, per 100 ft.	16.95
TV2—2 Cond. twisted Vinylite No. 22 wire, per 100 ft.	12.50
CC—Coax cable 50 Ohm, per foot	.10
CD—Coax cable 100 Ohm, per foot	.12

## Servicemen's Kits

No. 1S—12 popular speaker cones—5" to 12" with V.C.	Kit 4.95
No. 2K—50 Assorted Bakelite knobs all set screw, kit	4.75
No. 3N—100 Assorted knobs—push on & set screw, kit	6.95
No. 4C—100 Assorted By-pass and Buffer Condensers. Total value over \$20.00 Our price only	5.82
No. 5R—50 Assorted 5-10 & 20 Watt Resistors	5.95
No. 6C—100 Carbon Resistors—25 1W 75 1/2 W	2.94
No. 7C—200 Assortment 1/4 W Carbon Resistors	3.95
No. 8C—200 Assortment 1/4 W Ins. Resistors	4.95
No. 9P—50 Assorted padders and trimmers	2.95
No. 10E—50 Assorted Electrolytic Condensers	10.95

## Transformers

29P—Power Transformer 6.3V 3 Amp, 5V 2 Amp, 120V Input, 650V 90M	2.95
30P—5V—6.3V—600 V 100M	2.95
31P—Crosley 1014—10-tube Power Transformer	2.95
320—20 Watt Output Transformer 6L6—etc.	1.69

## Tube Bargains for Hams

307... \$1.70	829B... \$8.90	2AP1... \$ 4.90
807... 1.90	9001... 2.45	5BP1A... 12.45
866... 1.45	9002... 1.95	5FP7... 9.95
954... 4.90	9C03... 2.45	5R4GY... 1.80
855... 2.90	9C04... 1.95	6AK5... 1.69
8065... 4.90	9006... .94	7BP7... 14.90
8025... 8.90		VR-105... 1.37

We have one of the largest tube stocks in the country. Write for our list of tubes available for immediate shipment.  
Write for Latest Bargain Bulletin showing hundreds of items for servicemen and amateurs. Our stock is improving... new items being received every day.

**Lifetime**  
**SOUND EQUIP. CO., Dept. 20**  
911-913 JEFFERSON AVE., TOLEDO 2, OHIO

# Available Radio-Electronic Literature

Manufacturers' bulletins, catalogs and periodicals.

**A SERVICE FOR RADIO-CRAFT READERS:** In order to save your time, postage and incidental work in writing a number of letters to different manufacturers to secure the various bulletins offered, proceed as follows:

On your letterhead (do not use postcards) ask us to send you the literature which you designate. It is only necessary to give us the numbers. We will then send your request directly to the manufacturers, who in turn will send their bulletins or other literature directly to you.

## 244—PIEZO-ELECTRIC CRYSTALS

Aireon Manufacturing Corporation has issued an attractively illustrated catalog on crystals developed by them. Crystals are supplied to meet specifications for commercial or amateur applications in a variety of holders.—*Gratis*

## 245—DeJUR—AMSCO CATALOG

A 26-page booklet describing meters, rheostats and photocells manufactured by the company. Each type of equipment is illustrated photographically and also includes working drawings.—*Gratis*

## 246—DRY ELECTROLYTIC CONDENSERS

A four-page bulletin issued by Pyramid Electric Co. It describes their line of paper and aluminum-can types of dry electrolytic condensers. A capacitive inductive radio line-noise filter is also described.—*Gratis*

## 247—CARDWELL CAPACITORS

An illustrated catalog, published by Allen D. Cardwell Manufacturing Co., containing 16 pages of physical and electrical characteristics of variable and fixed air condensers ranging from midget receiving types to those designed for high-power broadcast service. Four pages are devoted to the Cardwell line of accessories and dials.—*Gratis*

## 248—CETRON PHOTOTUBES

An interesting 16-page booklet on the history and applications of the phototube published by Continental Electric Company. It also has six diagrammatic presentations of the applications of phototubes. A table of electrical and physical characteristics is included as a part of the booklet.—*Gratis to interested parties*

## 249—IRC CATALOG NO. 50

An eight-page catalog covering many of the various types of resistors manufactured by International Resistance Co. Also lists volume controls for special requirements.—*Gratis*

## 250—THERMOCOUPLE CATALOG

Charles Engelhard, Inc., has issued a catalog of thermocouples and associated accessories. This catalog is of particular interest to industrial manufacturers of apparatus using the items described in it.—*Gratis to interested parties*

## 251—SALES AND SERVICE HELPS

A complete list of store identification, sales promotion material, and store service helps is available through the Sylvania jobber. These include such items as imprinted match-book covers, shop coats and aprons, stationery and bookkeeping records, etc. An order form and price list for these items, some of which are free, is available through jobbers or from Sylvania direct.—*Gratis.*

## 252—VIBRATOR REPLACEMENTS

Presented by the Electronic Laboratories, Inc., this replacement guide for auto-radio vibrators is of wall-chart size, tinned on top and bottom to facilitate hanging. The chart lists all the more popular radio sets and many of the less popular ones. These charts are available through E-L jobbers and distributors.—*Gratis*

## 253—HERMETIC TERMINALS

A series of pamphlets and literature on hermetically sealed terminals, issued by Cincinnati Electric Products Company. These terminals are illustrated in photographs and working drawings. Of interest chiefly to radio and electronic manufacturers.—*Gratis*

## 254—POST-WAR RADIO PRODUCTS

A seven page catalog issued by the McMurdo Silver Company. This shows their new post-war line of test equipment, bridges, sockets, miniature tuning capacitors, and tuning units.—*Available to interested parties, gratis.*

## 255—ELECTRONIC PRODUCTS

A 16-page illustrated catalog by Eitel-McCullough, Inc., describing the many types of vacuum tubes designed for commercial, military and experimental use. Several pages are devoted to descriptions and photographs of vacuum capacitors, vacuum switches and vacuum pumps used in evacuating tubes.—*Gratis to interested parties*

## RADIO TERM ILLUSTRATED

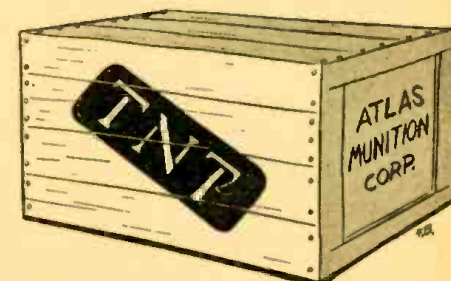

Suggested by: E. E. Youngkin, Altoona, Pa.  
Power Pack



## Radio Thirty-Five Years Ago

In Gernsback Publications

### HUGO GERNSBACK Founder

Modern Electrics	1908
Electrical Experimenter	1913
Radio News	1919
Science & Invention	1920
Radio-Craft	1929
Short-Wave Craft	1930
Wireless Association of America	1908

Some of the larger libraries in the country still have copies of Modern Electrics on file for interested readers.

From the AUGUST, 1911, issue of MODERN ELECTRICS:

Multiple Tone Wireless Stations, by Dr. Alfred Gradenwitz.

Mystery of the Ether, by Owen Ely.  
Lightning Phenomena, by Dr. Chas. P. Steinmetz.

A Static Machine, by Norman Bardeen.

A Flame Audion, by Mearle Melinger.

Automatic Arc Lamp, by C. R. Hampton.

Another Variable Condenser, by Rudolph W. Alsing.

The Electrical House.

A 100-Watt Step-Down Transformer, by Howard S. Miller.

Television.

Sensitive Pocket Galvanometer, by R. Neil Calvert.

Aluminum Solder, by Raymond Jenks.

Wireless Without an Aerial, by Ed. Egloff.

### SMALLEST RADIO TUBES

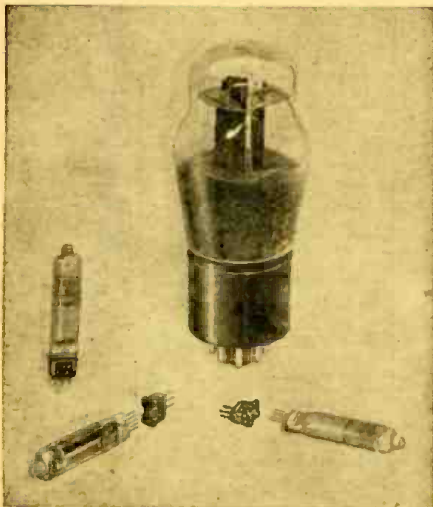

These new miniature tubes announced by Raytheon have sockets, thus making it easy to change tubes and ending the trouble of soldering connections. The new tubes are good at both radio and audio frequencies. Earlier hearing-aid tubes were not particularly efficient at frequencies above the audio spectrum.

### \$3.00 FOR YOUR IDEA

RADIO-CRAFT prints several radio cartoons every month. We invite you to contribute humorous radio ideas which can be used in cartoon form. It is not necessary that you draw a sketch unless you so desire. We pay \$3.00 for each original idea accepted. We cannot return ideas nor can we enter into correspondence in connection with them. Checks are payable on acceptance.

Address RADIO CARTOONS, RADIO-CRAFT, 25 West Broadway, New York 7, N. Y.

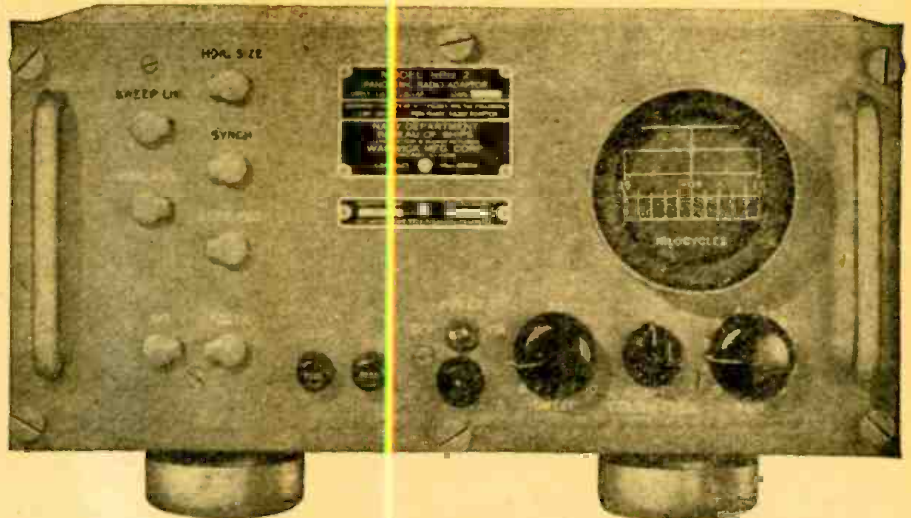

## Navy Panoramic Adaptors!

The Panoramic Adaptor tells you at a glance what is going on over a wide area of the band. When attached to your receiver, the adaptor will visually indicate whether there are signals present within the area covered. It will show the relative frequency of each signal, relative signal strength, the type and percentage of modulation. This Navy unit was built to rigid specifications without consideration of cost. It will allow you to locate "holes" in crowded bands, detect weak signals, and contribute generally to the improved operation of your station. The RBU-2 covers a continuous band of frequencies 50 Kc. wide. Operates on 115/230 V.A.C. 50/70 cycles. New and packed in original crates. Tropicalized.

PRICE ONLY **\$94.50**

F.O.B. Chicago

### ARMY WALKIE-TALKIES!

The BC-322 is a complete, portable radio communication set. It is light enough to be strapped on the back and powerful enough for dependable voice transmission over a range of 10 to 20 miles. Frequency band 52 to 65 Mc. These sets are new in original crates. The low price includes tubes, handset, telescopic antenna, batteries and battery adaptor, and carrying case. \$75.00 F.O.B. Chicago. Model BC-222 has two bands but otherwise the same as the BC-322. Frequencies from a 28 to 38 Mc. and 38 to 52 Mc. These sets have been in service but have been renewed by the Government. New batteries. No carrying case.

PRICE ONLY **\$45.00**

F.O.B. Chicago

## Government Termination Material

Condensers	Transformers
Resistors	Volume Controls
Spaghetti	Vibrators
Switches	B-L Selenium
Transmitting Tubes	Rectifiers
Wire-Cable	Dial Light
Relays	Assemblies
Tube Sockets	Whip Antennas

**WELLS SALES, INC.**  
4717-J W. Madison St.  
Chicago 44, Ill.

### USE COUPON BELOW FOR COMPLETE INFORMATION

WELLS SALES, INC., 4717-J West Madison Street, Chicago 44, Illinois

Please ship.....for which \$.....is enclosed

Please mail free Amateur Radio Circular.

Please send prices and information on the following items:.....

NAME .....

ADDRESS .....

### BEAUTIFUL WALNUT CABINET CUT TO FIT MEISSNER 6-TUBE KIT Mdl 10-199



Cabinet Mdl M-1 Your Cost \$3.95  
Write for latest parts Catalogue  
McGEE RADIO CO., 1330 Bdw, DENVER, CO. LO.

Magnetic buttons for garments are proposed in a recent patent granted to Robert Ellis of York, Penna. The buttons are described as easy to manipulate but firm against the stresses met in ordinary wear.

## Do you need BINDING POSTS?



The XL PUSH POST with its Spring Action assures Constant Contact and Quick connection.  
Manufactured in All Aluminum Type M at 12c each.  
Aluminum Body, Bakelite Top Type M at 15c each.  
Types CP or NP, ALL BRASS-STAINLESS STEEL SPRING & PIN, PROVEN by 240 HR. SALT SPRAY TEST as NON-CORROSIVE at 28c each.  
Manufacturers and Dealers Liberal Discounts

**X. L. RADIO LABORATORIES**  
420 West Chicago Ave., Chicago 10, Ill.

### SPECIALS

Insulated Resistor Kit Assortment. Consists of 100 1/2-1-2-3 Watt popular values..... \$3.75  
Phono Amplifier Kit. Includes motor, Dick-up, and complete kit of parts for amplifier—less tubes..... 14.95  
Complete Portable Record Player. In attractive case. Ready Wired—less tubes..... 24.95

Write for bargain bulletin

**TECHNICAL RADIO LABS**

341 Wilson Ave. Brooklyn 21, N. Y.

# IN PHILADELPHIA - IT'S ALMO RADIO COMPANY

★ PHILADELPHIA'S  
NEW WHOLESALE RADIO  
AND ELECTRONIC PARTS  
DISTRIBUTOR!

## THE WATERMAN POCKETSCOPE A POCKET-SIZE OSCILLOSCOPE

YOUR COST  
**\$55**



Small in Size  
Light in Weight  
Complete in  
Performance

The Model S-10-A POCKETSCOPE is a small, compact, lightweight instrument for the observation of repetitive electrical circuit phenomena. The POCKETSCOPE is a complete cathode ray oscilloscope incorporating the cathode ray tube, vertical and horizontal amplifiers, linear time base oscillator, synchronization means and self-contained power supply.

The POCKETSCOPE is capable of indicating in two independent dimensions—vertical and horizontal. As used normally, the vertical dimension is amplitude, and the horizontal may be either amplitude or time. However, by means of external signals, any variable can be assigned to independent dimensions. Although it has practically unlimited application, some of its common uses include study of wave shapes—measurements of modulation, frequency, phase shift, voltages, power, distortion—adjustments of audio-amplifiers, radio, television and FM receivers and transmitters as well as any other apparatus producing electrical waves—tracings of vacuum tube characteristics, hysteresis, and other curves.

The POCKETSCOPE weighs only 5½ lbs. and occupies less than .15 cu. ft. of space. The cathode ray tube is magnetically shielded and the telescoping light shield (1 inch) permits observation even in places of high light intensity. The angle of vision is great. The construction of the POCKETSCOPE permits its physical use on the floor, on the bench, or in any position convenient to the operator without diminishing the wide angle of vision.

The response of the vertical and horizontal amplifiers is within 0 to -2DB from 20 cycles to 100 KC, and is within -5DB to 200 KC. Any variation from 1KC is downward, thus there are no positive slopes that produce non-linear phase shift.

**ALMO**  
**RADIO COMPANY**  
509 Arch Street  
PHILADELPHIA 6, PA., LOmbard 3-0513

## CHECK LIST FOR REPAIRMEN

(Continued from page 764)

plate voltage very near the filtered B supply voltage. The audio stage or stages should have a plate voltage of about 2/3 the B supply, depending on the type of voltmeter used. The second detector diode plates should have a low voltage, either positive or negative, depending on the particular circuit used, but it should vary as the condenser is tuned across a station if all stages from the antenna to the second detector are functioning properly.

d—Measure the screen-grid voltage of all tubes. Whether or not an a.c.-d.c. model, the voltage should be about 100 volts on the r.f. amplifier, mixer, and i.f. amplifier tubes. Output tubes, if they are pentodes or beam power tubes, usually are operated with the screen grids at full B voltage.

e—Measure the cathode voltage of all tubes. Cathode voltages will be either zero or a low positive value. If a cathode voltage is as high as the screen grid or plate voltage, it indicates an open cathode bias resistor or an open lead between cathode and ground. The cathode voltage of the output tube will be the highest of any of the tubes if the set is operating properly and will vary from about 6 volts in an a.c.-d.c. receiver to about 60 in a large transformer set with a push-pull output stage.

f—Measure the voltage between the control grid and CATHODE of all tubes. With a few exceptions, the grid should be negative with respect to its cathode. If the output tube is 6AC5 or 25AC5 the grid voltage may be about 15 volts above its cathode. If the grid voltage of any stage other than a direct coupled stage employing a tube similar to a 6AC5 is more positive than

its cathode, check the coupling condenser or transformer between the grid and the plate of the tube preceding it.

g—Measure the a.v.c. voltage if you have a vacuum tube voltmeter or a voltmeter whose sensitivity is better than 5000 ohms per volt. An a.v.c. voltage measurement taken with a lower sensitivity voltmeter is not reliable, and would be meaningless in most cases, since it would place a low resistance shunt across the high impedance a.v.c. circuit.

### 4. SIGNAL TRACING

a—A form of signal tracing is employed by every serviceman, whether or not it is known by that name. Two methods of signal tracing are in use today: The screwdriver method; and the instrument method. Each has its advantages and disadvantages, but the instrument method is strongly recommended. A signal tracing instrument is nothing more than a detector followed by a high gain audio amplifier. When signal tracing in the audio stages of a receiver, the detector stage of the signal tracer is by-passed by some switching arrangement or biasing scheme and the instrument is merely an audio amplifier.

b—Place the probe of the signal tracer on the antenna post of the receiver. Several stations should be heard.

c—Advance to the grid of the r.f. amplifier (or mixer grid if the set has no r.f. amplifier) and tune in a station with the receiver's station selector (tuning condenser).

d—Next, check the plate of the stage—the signal should be stronger. Follow through all r.f., mixer (converter) and

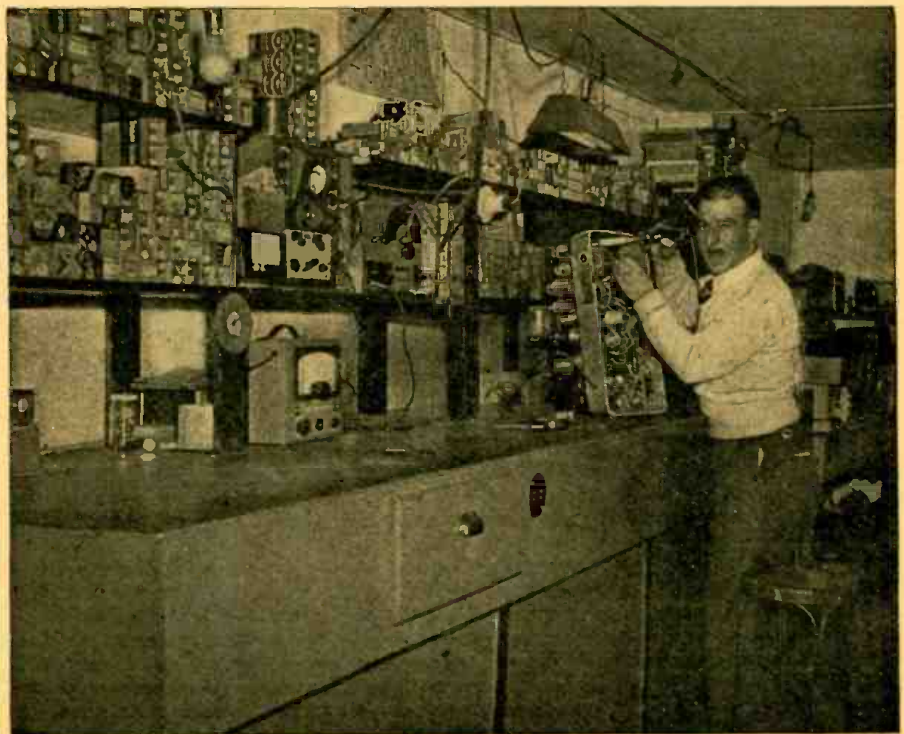

"Keep the bench clear" is the motto of this shop. Tools are out of sight in closed drawers.

RADIO-CRAFT for AUGUST, 1946

i.f. stages, testing grids and plates for the signal. If the signal is not heard at one of these points, you have located a stage that is not functioning properly. Trace out the circuit around this point with an ohmmeter, watching for open circuits, shorts, etc. This information, together with voltages already measured, will enable you to determine the trouble and correct it.

e—After the r.f. and i.f. stages have been tested, the signal tracer is changed over to audio, and the audio stages are tested in the same manner.

f—If the shop does not have a signal tracer, the screwdriver method is used. The grid of the output stage is momentarily shorted to chassis or ground with a metal screwdriver. A click should be heard in the speaker. Then short the grid of the tube feeding the output tube. A louder click should be heard. When a grid is shorted that does not produce a noise in the speaker, you have located the faulty circuit. Repair and continue back through the set until at last you are shorting the antenna post to ground. The click in the output should be heard.

g—An audio oscillator and r.f. signal generator may be substituted for a screwdriver, but their use will require more time than either of the two methods just described. These two instruments will be used for alignment and test, so for merely isolating trouble, save as much time as possible and locate the fault quickly.

#### 5. REPAIRS AND REPLACEMENTS

a—Use exact replacement parts supplied by the radio's manufacturer whenever possible.

b—When replacing resistors, by-pass condensers, etc., use a quality part. You will save money in the long run by using quality resistors, condensers, coils, and transformers and your repair work will stand up, thus giving you and your business a good reputation.

c—Use rosin core solder, and make neat soldered joints. Soldered joints that look like tinned cabbage heads are a risk electrically and mechanically.

d—In these days of tube shortages, be honest with yourself and your customer. If a substitution must be made, use the closest substitute available. Do not replace a high- $\mu$  triode with a low- $\mu$  triode. Most commercial radios are well engineered, and they will not give standard performance if unwise tube substitutions are made. By all means, give the customer the best job of which you are capable.

#### 6. TEST ALL CONTROLS

a—The actual repair of the receiver is now completed, and all circuits are in working order. If a r.f. coil, i.f. transformer, or oscillator coil has been replaced, you may have to roughly align the set at this point before continuing with this series of checks.

b—Test the tuning control for mechanical operation and note whether the dial "tracks."

c—Throw the main power switch several times to see that its action is positive.

d—In like manner try the volume control, tone control, phono-radio switch and band changing switches.

e—Tune the receiver across a station and observe the action of the tuning indicator or "eye" if the receiver is equipped with one.

#### 7. VIBRATION TEST

a—Select a station on the receiver and listen a few minutes to accustom yourself to the tonal quality and background noise of the receiver.

b—Test for noisy or microphonic tubes by sharply tapping each tube with the wooden handle of a screwdriver of similar instrument.

c—Rap the chassis on the work bench or strike it several times with a heavy rubber mallet to see if vibration produces any noise in the output.

d—A noise in the output produced by vibration indicates a defective component or connection, and should be eliminated.

#### 8. SENSITIVITY CHECK

a—If the manufacturer's data on absolute sensitivity of a set is known you should try to bring up the sensitivity of the receiver to that value. However, this information is usually not available to the serviceman and other tests must be devised.

b—Compare the repaired receiver's performance with that of a comparable receiver known to be in very good condition. Use the same antenna on both receivers when making this test. The sensitivity should be tested on several stations scattered over the entire tuning range of the receiver. If the sensitivity of a receiver after repair is appreciably below that of a receiver with comparable tube line-up and power supply, it indicates that complete alignment is necessary. However, if its sensitivity is good, the serviceman should use his own judgment as to whether or not a particular receiver needs a complete realignment.

#### 9. ALIGNMENT PROCEDURE

a—If the sensitivity of the receiver is below par, it should be aligned according to manufacturer's directions.

b—If neither manufacturer's procedure nor circuit manuals are available standard procedure for superhet alignment should be used. This can be found in nearly any radio handbook. (It is assumed that the greatest percentage of receivers will be superheterodynes.)

c—The serviceman will encounter some t.r.f. receivers, and it goes without saying that t.r.f. alignment procedure will be used on this type.

#### 10. TWO-HOUR CHECK

a—Now that the receiver has been repaired, aligned, and its sensitivity checked, it should be removed from the service bench and set up at some other location in the shop. It is turned on, tuned to a station and allowed to play for about two hours.

b—At the end of this *time trial*, the sensitivity is again checked. If the set still checks O.K., it is ready for delivery to the customer.

# TRUTONE

PREPARED ASSORTMENTS  
GUARANTEED FIRST QUALITY

Cat. No.	Quantity	Description	Price
1001	100	1/3 Watt Resistors, All Insulated	\$2.98
1002	100	1/2 Watt Resistors, All Insulated	3.98
1003	100	1 Watt Resistors, All Insulated	4.43
1004	50	2 Watt Resistors, All Insulated	3.98
1005	10	Wire Wound Resistors Ass't'd	
		Watts	2.98
1006	50	200 Volt Paper Condensers	2.48
1007	50	400 Volt Paper Condensers	3.49
1008	50	600 Volt Paper Condensers	4.23
1009	50	Mica Condensers	2.98
1010	20	Dry Electrolytic Filter Condensers	6.75
1011	10	Resistance and Line Coils	3.98
1012	100	Wafer Sockets	4.50
1013	100	Plastic and Ceramic Sockets	8.50
1014	10	25 Ft. Rolls Hookup Wire—Ass't'd Colors	1.98
1015	10	50 Ft. Rolls Hookup Wire—Ass't'd Colors	3.25
1016	10	100 Ft. Rolls Hookup Wire—Ass't'd Colors	6.75
1017	10	Volume and Tone Controls—No Switches	1.98
1018	50	Large Bakelite Knobs Push On	6.50
1019	50	Large Bakelite Knobs Set Screw	7.85
1020	50	Small and Medium Knobs Push On	3.50
1021	50	Small and Medium Knobs Set Screw	3.75
1022	100	Small Bar Knobs	5.90
1023	100	Large Bar Knobs	6.75
1024	100 ft.	Spaghetti and Vinylite	.98
1025	50	Padders and Trimmers	1.48
1026	10	Coils L.P., R.F. Ant. and Osc.	2.98
1027	50	Pilot Lamps	2.49
1028	20	Toggle and Slide Switches	3.98
1029	20	Wafer and Ceramic Band Switches	3.98
1030	20	Auto Generator Condensers	2.98
1031	20	Auto Suppressors	2.98
1032	25	Electrical Wiring Devices, Plugs, Caps, Bases, Heater Plugs, etc.	2.75
1033	50	Electrical Wiring Devices, Plugs, Caps, Bases, Elements, Fuses, etc.	5.00

#### ELECTRICAL APPLIANCES AND PARTS

Double Burner Electric Stove	OPA \$ 7.00	\$ 5.95
Streamlined Electric Broiler Deluxe type	OPA 17.45	12.50
Fluorescent Desk Lamp, Brown	OPA 11.95	7.75
Blue or Rust Fluorescent Kitchen Unit	OPA 10.80	6.75
Electric Phonograph	OPA 48.50	39.95
Replacement Stove Element 660 W.		.12
Replacement Electric Iron Element 550 W.		.55
Replacement Toaster Element		.75
Electric Iron Cord Set, Bakelite Plug		.45
Electric Iron Cord Set, Switch Plug		.80
8 ft. Extension Cord with Cube Top		.45
6 ft. Rubber Replacement Cord		.25

#### SEND FOR TRUTONE COMPLETE RADIO AND ELECTRICAL LIST

Terms: 25% deposit required with order, Balance C.O.D. Merchandise sent prepaid if full remittance accompanies order.

#### TRUTONE PRODUCTS CO.

303 West 42nd Street, Dept. C, New York (18), N. Y.

# FLANAGAN RADIO CORP.

America's Largest Stock of Radio Tubes

## RADIO TUBES

STANDARD BRANDS  
ALL GUARANTEED

Flanagan carries a complete stock of all hard-to-get RADIO TUBES. Write for available tube numbers and price list.



## CRYSTAL PICKUPS



\$2.50  
e.a.

COMPLETE  
WITH  
HARDWARE

## RECORD CHANGERS

V. M.  
2-POST  
AUTOMATIC

Brand new—Sealed Cartons. Only at Flanagan's at this low price. Plays 10" and 12" records mixed. Crystal Pick-up.



\$21.88

## RADIO SETS

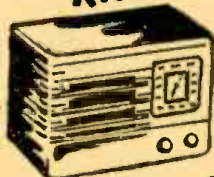

5-Tube Superhet  
Built-in  
Loop Antenna  
List Price \$31.55  
Our Price \$24.67

## RECORD PLAYERS

BEAUTIFUL  
PORTABLE  
CASE  
3 TUBES  
VOLUME  
AND  
TONE  
CONTROL

List Price \$48.66

Our Price \$36.40



## FREE CATALOG

Send for free catalog and prices of hard-to-get Radios, Radio Tubes, Radio Parts, Pick-ups, Motors, Condensers, Tube Checkers, Volt & OHM Meters, Signal Generators, Signal Tracers, etc.

WE SHIP ANYWHERE

# FLANAGAN RADIO CORP.

America's Largest Stock of Radio Tubes  
N.E. Cor. 7th & Chestnut Sts., Phila. 6, Pa.

## WIDERANGE POCKET TESTER

(Continued from page 749)

quired for range selection. The a.c.-d.c. changeover switch is of the d.p.d.t. toggle type. The power line switch for current and wattage measurement is the push to close variety.

To obtain maximum a.c. sensitivity and linearity and still use a 1-ma meter, the full-wave bridge type meter rectifier is employed.

The case for this tester was home-constructed. Bakelite is used for the entire box. Two thicknesses are necessary. The panel and bottom measure 4 x 7 inches and is 3/16 thick. Sides are 3 x 7 x 3/16 inches. For the ends 3/8-inch thick material is used and the two pieces measure 3 x 3 3/8 inches. Meter holes may be cut with a coping saw or circle cutter and then filed smooth. Three holes will have to be made in one end for power input, receptacle and push button.

### MAKING THE SHUNTS

These may be constructed with a fair degree of accuracy and later adjusted to exact values. All the current shunts can be wound on one piece of plastic rod, the ohmmeter and condenser resistors on another. Exact value shunts and resistors can be purchased, thus saving a lot of calibrations.

Winding the copper shunts is just as important as is obtaining the correct

length of wire. Since copper stretches very easily no attempts should be made to wind tightly. Loosely wound bobbins will therefore be more accurate than a

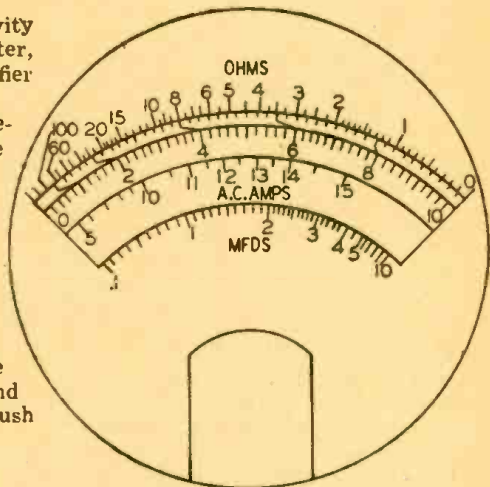

Fig. 2—Facsimile of the special meter scale.

nice looking tight-wound one.

5 feet 3-4/5 inches of No. 20 wire will equal .055 ohms. 5 feet 2 1/2 inches of No. 30 wire will equal .55 ohm. 57 feet 6 inches of No. 30 wire will equal 6.05 ohm. 42 feet 5 1/4 inches of No. 40 wire will equal 45.4 ohm.

Odd value resistors may be made up by series or parallel combinations. 700 ohms in parallel with 800 ohms will make a 370-ohm resistor. The 7800-ohm resistor can be made up with a 7500-ohm and a 300-ohm resistor in series. Multipliers are one watt unless marked otherwise.

Three types of markings are needed on the dial; an ohmmeter scale showing 45, 450 or 4500 ohms at the center point; calibrations for 1, 10, or 100 d.c. ranges and an a.c. marking for making low voltage readings. These dials are available at most supply houses and come in different types for the various meter makes. The correct dial for your meter is ordered by the meter model number. The original 1-10 dial scale may be used and charts made for a.c., ohms and capacity scales. The scale in Fig. 2 was drawn by the author, and represents several hours work.

### CALIBRATION CHECK

With the box made, shunts wound and assembly completed, a check for accuracy can be made. Exactness can be compared with a quality multimeter, and any inaccuracies adjusted. A substitution method for checking is possible.

A fairly accurate check of voltages may be made with new batteries of good make, with a bleeder across them to draw a small current. In some cases a voltmeter covering one of the scales may be obtained and a battery voltage measured exactly with it, then used to calibrate other scales.

(Continued on page 801)

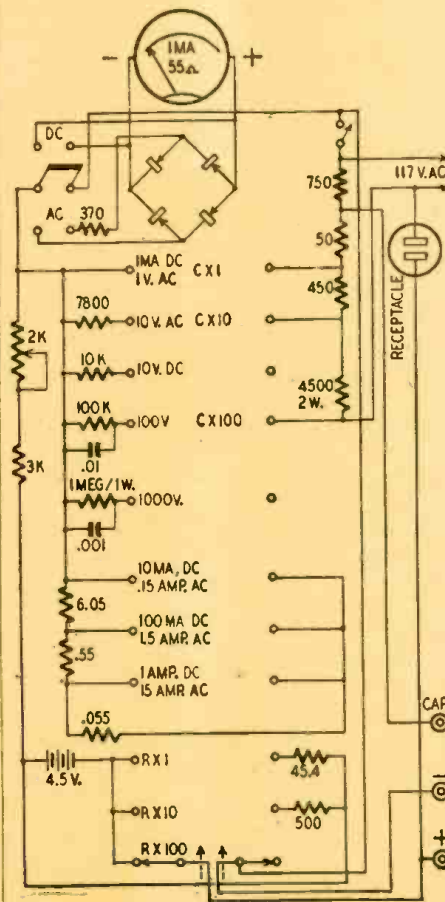

Fig. 1—Schematic of the Widerange Tester.

## TRACER PLUS POWER SUPPLY

(Continued from page 757)

many simple causes of intermittents.

If this fails, turn the chassis upside down on the service bench, tune a station in and let it play. When the intermittent set cuts out, do not touch it; do not let any metal object such as a pair of pliers or a screw driver come in contact with the chassis or any metal part of the receiver as this would in all probability cause the radio to start playing again.

Switch on the signal tracer. Here again a word of caution. Occasionally, on really stubborn intermittents, the line surge caused by switching on the tracer will cause it to cut in again. In this case the tracer should be switched on at the same time as the intermittent receiver so that it will be ready when the intermittent recurs.

Place the special test prod flat against the plate lug of the mixer tube socket. It may be necessary to shift the dial setting slightly to compensate for the slight detuning effect of the probe. There will be no contact surge because there has been no contact. The surface of the

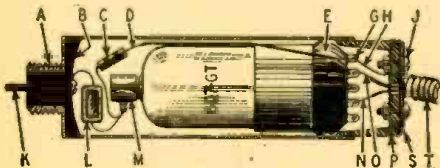

Fig. 4—The triode probe. A—Insulating tip of electrolytic can. B—Insulating packing inside can. C—Grid leak. D—Grounding wire. E—Octal socket. G—Connection to one filament and cathode prongs. H—Common lead to ground. J—Common ground post. K—Threaded tip. L—Blocking condenser. N—Plate lead. O—"Hot" filament lead. P—Large tube base. S—Metal ground plate. T—Spiral wire guard.

socket lug acts as one plate of a condenser and the probe acts as the other plate; the mica is the dielectric.

If a signal is heard at the plate of the mixer, we know that the signal is not being interrupted between the antenna and oscillator plate. Next place the probe on the plate lug of the first i.f. tube. Again there will be no contact surge. We may thus check a receiver from antenna post to voice coil with no danger of causing a surge that might cause it to start playing again, and the exact point at which the signal is being cut off may be determined.

In servicing portables and battery sets a No. 6 dry cell may be used as an A battery. Plate voltage may be taken from the tracer by connecting the negative battery terminal to the tracer ground and the positive battery terminal to the variable-voltage pin jack. The voltage control is advanced until proper plate voltage is applied to the set. It is possible to note the lowest plate voltage on which the set will operate. This is indirectly an indication of oscillator circuit efficiency. For instance, if a set designed to operate on 90 volts suddenly cuts out at about 80 volts it is a certain indication that the oscillator cir-

cuit has ceased to function. This tube and circuit should be thoroughly checked.

A.c. sets with inoperative power supplies may be connected and checked in the same manner except that plate voltage is supplied from the 180- or 250-volt pin jack. This voltage will drop under load, the amount of drop depending on the load. This places a slight overload on the tracer power transformer, but the transformer will not be damaged if the load is of short duration (fifteen to thirty minutes). When drawing current from the 250-volt pin jack it is advisable to open the bleeder switch, thus removing its load from the power supply.

With power off, the component parts of the power supply, the output transformer and speaker may be used for substitution.

When using filter choke in external circuit, connect leads to pin jacks 5 and 6 and open Sw3 (1st filter switch) to prevent shunting by the filter condensers. When using milliammeter externally connect leads to pin jacks 4 and 5, and open Sw5 (bleeder switch). When substituting power transformer, open Sw1 (ganged to Volume Control 1) and pull 5Y3 out of socket to remove its drain from transformer.

The audio input jack may be switched to the 6J7 grid. This is useful in checking phono pickups, microphones, PA and theater sound systems. When switched to the 6F6 grid, only the power stage is in circuit. This is very useful in tracking down obscure causes of distortion in sound systems, and for substituting only the output stage in receivers under test.

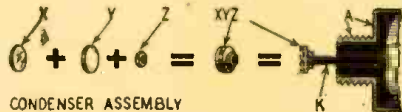

Fig. 5—Intermittent tip. X—The mica plate. Y—Small copper disc. Z—Hex nut. XYZ—Assembly ready to screw to threaded probe tip.

In using the power supply to furnish plate voltage to any set, always take care to connect the negative lead to the proper point in the set. This is not always ground but in many cases is a point connected to chassis through a resistor, choke or speaker field. This is readily determined by an examination of the circuit.

The serviceman who builds this instrument and uses it in his work will soon develop a new technique resulting in greater speed, efficiency and more accuracy in diagnosing obscure troubles.

### ROTA-BASE

NEW HANDY LAB. DIAL. Simply turn the movable dial to the tube number desired on the ROTA-BASE and complete, correct connections are instantly indicated on the "prong" diagram. Filament, Grid, plate, cathode, etc., in more than 300 tube types are given. No more valuable time lost on lengthy reading or thumbing of pages. ROTA-BASE actually gives a "prong" picture of the connections. PRICE NOW ONLY \$1.00. Postage prepaid or sent C.O.D. plus postage. Money back if not delightfully pleased.

REED MFG. CO. 411 S. Main St. Los Angeles, Calif.

## BARGAINS

we call

'em;

You'll call

'em

GIFTS

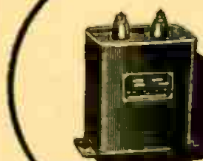

FAMOUS BRAND  
HERMETICALLY-SEALED  
OIL CONDENSER

Finest quality oil-filled, rectangular uprights. 8 mfd. 600 volts. Size: 5 7/8" x 3 3/4" x 1 1/4". Weight: 2 lbs.

WPS414 only \$1.49

### LOOK AT THIS BUY!

TYPE TLA DYKANOL CONDENSERS—For compact high-voltage filter applications on high-fidelity P.A. amplifiers; power supplies for short wave portable transmitters and transceivers. 2 mfd. 600 volts D.C. Size: 2 3/8" x 1 1/2". 4 mfd. 600 volts D.C. Size: 4 1/2" x 1 1/2".

XPS498 2 mfd. Only 59c  
XPS499 4 mfd. Only \$1.19

These buys are typical of what you can get from the world's largest and oldest suppliers of radio and electronic equipment, and we've got thousands more of 'em. Use coupon below; orders filled pronto!

# FREE

Latest Bargain Flyer C-37 gives you up-to-the-minute news on Lafayette's unbeatable bargains. Send for it today! Also, get on the mailing list for Lafayette's Super Catalog, jam-packed with dollar-saving values. Covers everything in radio and electronic equipment.

## LAFAYETTE RADIO

RADIO WIRE TELEVISION, INC.  
New York 13 • Boston 10 • Newark 2

PASTE ON PENNY POSTCARD. MAIL TODAY!

LAFAYETTE RADIO, Dept. JH-6  
100 Sixth Ave., New York 13, N. Y.

Enter my { ..... } WPS414 oil condenser(s)  
order for { ..... } XPS498 TLA condenser(s)

Check encl.  Money order  Send C.O.D.  
 Send me FREE copy of Bargain Guide C-37  
and place my name on mailing list for new Lafayette Catalog.

Name \_\_\_\_\_

Address \_\_\_\_\_

City \_\_\_\_\_ Zone \_\_\_\_\_ State \_\_\_\_\_

**RADIONIC EQUIPMENT CO.**

APPROVED  
ELEC-  
TRONICS  
A-100



**SIGNAL GENERATOR**

A complete instrument incorporating all of the features necessary to give you a solid, dependable signal. Accurate calibration in 6 ranges covering 100 kc. to 52 mc. Provision for internal or external modulation continuously variable from 0-100%.



**VOMAX**  
**\$59.85**

The vacuum tube voltmeter that meets every measurement need—57 ranges.

NEW!  
POCKET-SCOPE  
BY  
WATERMAN

**\$53.90**



An oscilloscope that has all the conventional features but in a unit 10% of the usual size. A 2" CRT that can be viewed at any angle. Hor. and ver. amplifiers with excellent freq. characteristics. Sweep circuit substantially linear from 10 to 50,000 cycles. Miniature tubes. Well designed power supply. Convenience PLUS! 4 x 6 1/2 x 1 1/2 inches. 6 lbs.

**CHANCELLOR**



**\$17.95**  
**RECORD  
PLAYER**

Shure crystal pickup; drawn aluminum case; plastic turntable; 10,000 play Precious Point needle; handsome baked brown lacquer finish; 115V AC motor; all combine with excellent design and workmanship to give you a dependable record player of first-class appearance at a remarkable price.

- INVERTER, 110 V DC to AC, 25 Watt (Ideal for phono players) **\$7.15**
- MEISSNER Coil Kit, 456 lbs. (Shielded input and output, unshielded osc.) **1.99**
- ANTENNA Coil **.49**
- 12" PM Speaker, 20 oz. **6.25**
- Rub-R-Lite Flashlight, less bat. **1.85**
- Lots of 1. **13.35**
- CAT WHISKERS, Kit of 3 **.05**
- EL VIBRATORS, 1703-2041-2088-2089 **2.09**
- Auto and Farm Sets **3.50**
- RIDER'S MANUALS, VOL. VI **11.00**
- Vols. IX, XI, XIII, and XIV each **15.00**
- 50L6 output transformers **.49**
- Standard Fluke Universal Output trans. 6 watt **1.20**
- STANCOR P 6011, 7 tube, 70 ma. 6.3 Fil **3.38**
- STANCOR P6012, 9 tube, 90 ma. 6.3 Fil **3.82**
- ANTENNA Kit, 50 ft. ant. wire **.79**
- 25 ft. leadin, 2 ground straps, 2 insul., 2 screw eyes, 2 nail knobs. Lots of 5 **.65**
- 5" PM SPEAKER **2.15**
- 6" PM SPEAKER **2.45**
- 8" PM SPEAKER **3.60**
- WEBSTER, Models 50 and 56 Chancellor Portable Record Player in simulated ALLIGATOR leather **36.95**

Write Dept. W5 for FREE CATALOGUE of parts, Test, Sound equipment, and accessories.

TERMS: Full payment with order or 25% deposit. Balance C.O.D. Include Postage.

**RADIONIC EQUIPMENT CO.**  
170 Nassau St. New York 7, N. Y.

**THE "SONICATOR"**  
(Continued from page 752)

Fig. 3. A brass strip (screwed to the polystyrene strip on the disc support) makes contact with a slip ring behind the disc. The brass strip, or brush, is connected to the amplifier's output, and the slip ring to the neon tube. The tube's other terminal is grounded to the disc shaft. Thus assures constant contact with the rapidly rotating neon tube, which flashes whenever a pulse of sound is received and amplified.

A smaller disc at the end of the shaft carries a pin which closes a microswitch once each revolution, discharging the condenser C of Fig. 1 through the transformer primary and thus sending out a short, sharp sound impulse, of only about one cycle at the 10-ke frequency. Since the switch and neon light are on the same shaft, synchronism is absolute.

Transmission of the signal results in a sharp flash of light from the neon tube, at the bottom of its circle of rotation (zero feet). The sound wave travels out to any object that can reflect it, the reflected signal comes back, is concentrated by the parabolic reflector and directed to the microphone, amplified and applied to the neon tube, causing a second flash. Since the flash is repeated every second, it appears to stand still unless the distance between the Sonicator and the object is changing.

The speed of sound is roughly 1100 feet per second. Therefore at the end of its one-second revolution a neon tube will react to a sound signal which has traveled that distance (been reflected back from an object 550 feet away). An object 275 feet away will cause a flash at the top of the ring. Distances as short as five feet can be measured.

Possibly the only other special detail is the method used to contact the rotat-

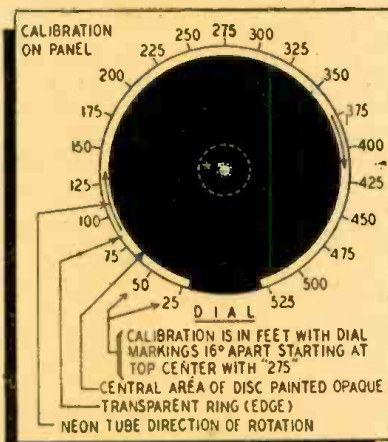
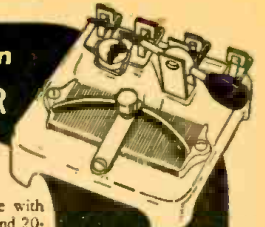

Fig. 2—The calibrated dial. The divisions will be nearer to 16.3 than 16 degrees apart.

ing reflector. This was done by making the shaft which holds it of hollow bakelite. A brass cylinder driven inside the shaft acts as ground, and fitting over a stub on the chassis, is also the bearing on which the assembly turns. Other cylindrical brass rings driven over the

**Build Your Own  
RADIO RECEIVER**

And listen to your own radio programs—this Kitecraft Radio Set brings them in clear as a bell. Easy to build; works anywhere. Complete with mica condenser, tested galena crystal and 20-page illustrated manual containing diagrams, theory and step-by-step building and operating instructions. Base of "Lucite" plastic; no soldering or batteries required. Uses any type earphone. Thousands in use. MONEY BACK GUARANTEE. Sent prepaid or C.O.D. plus postage. ORDER TODAY! Dept. EC-8



only  
**\$2.95**  
complete  
less phones

KITCRAFT INC. 614 North San Vicente, Los Angeles 46, California

**ELECTRONIC VOLT-OHMMETER**

**\$1185** 110 VOLTS AC 20 RANGES  
0.5/10/50/100/500/1000/5000 volts DC and AC. 0-1,000,000,000 ohms in six overlapping ranges. Sensitivity: over MILLION OHMS per VOLT on 5 volt range.

POSTPAID Complete kit includes all component parts, tubes, punched and drilled chassis and beautifully enameled panel. Easily assembled and wired.

Special millidback circuit developed during war by scientist at the California Institute of technology gives amazing sensitivity and flexibility while completely eliminating necessity of batteries and expensive meter. Each instrument is individually calibrated. Dial scale over nine inches long!

In addition to performing the usual volt-ohm functions, this instrument easily measures these voltages: SUPERHET OSCILLATOR, AVC, APC, TUBE GRID BIAS AT THE GRID, BIAS CELLS without affecting the circuit. Measures the exact leakage resistance of INSULATION, TUBES, CONDENSERS. It can be used with a signal generator for SIGNAL TRACING.

**STERLING ELECTRONIC COMPANY**

166 N. Sierra Bonita Ave., Dept. 2, Pasadena 3, Calif.

**OPPORTUNITY AD-LETS**

Advertisements in this section cost 20 cents a word for each insertion. Name, address and initials must be included at the above rate. Cash should accompany all classified advertisements unless placed by an accredited advertising agency. No advertisement for less than ten words accepted. Ten percent discount six issues, twenty percent for twelve issues. Objectionable or misleading advertisements not accepted. Advertisements for September, 1948, issue must reach us not later than July 25, 1948. Radio-Craft • 25 W. 57th St. New York 7, N. Y.

MAGAZINES (BACK DATED)—FOREIGN, DOMESTIC, arts, books, booklets, subscriptions, pin-ups, etc. Catalogs 10c (refundable). Clearance: 863 First Ave., New York 17, N. Y.

AMATEUR RADIO LICENSES, COMPLETE CODE and theory preparation for passing amateur radio examinations. Home study and resident courses. American Radio Institute, 101 West 63rd Street, New York City. See our ad on page 808.

CORRESPONDENCE COURSES AND SELF-INSTRUCTION books, slightly used. Sold, Rented, Exchanged. All subjects. Satisfaction guaranteed. Cash paid for used courses. Complete information and 92-page illustrated bargain catalog free. Write—NELSON COMPANY, Dept. 2-39, Chicago 4.

SURPLUS RADIO AND ELECTRONIC PARTS and equipment. New and used. Write for free list. High-bridge, 312 Canal St., New York City 13.

WE REPAIR ALL TYPES OF ELECTRICAL INSTRUMENTS, tube checkers and analyzers. Hazelton Instrument Co., (Electric Meter Laboratory) 140 Liberty St., New York, N. Y. Telephone—BARELAV 7-4339.

EXPERIMENTER'S "RADIOBUILDER"—10c. PARTS, Data, Laboratories, Box 1-b, San Carlos, California.

NAVY RADAR OSCILLOSCOPES—ARR MODELS. Complete with 5BP1 and 4-6A87 tubes, high gain amplifiers, rich, highest quality components. Tested before shipment. Special \$25. Send for list of bargains in Navy radar equipment. Seaboard Surplus, P.O. Box 719, Jacksonville, Florida.

3 RCA 1840 ICONOSCOPE PICKUP TUBE. BRAND new in original wrapping. Substantial discount for quick buyer. Room 772, 11 West 42 Street, New York City. Longacre 5-1818.

HAMS AND S.V. FANS: HOP UP THOSE WEAK SIGNALS. Preselector for your receiver. Neatly designed, brand new, with acorn tube, 10 or 20 meters. Specify—\$12.50. Constant Electric, 113 Cornelia St., Brooklyn, N. Y.

RADIO TUBES, PARTS WHOLESALE. BULLETIN 3c. Henshaw Radio Co., 3313 Delavan, Kansas City, Kansas.

WAR SURPLUS RADIO PARTS—IN21 SYLVANIA Crystal 98c. Condensers, Resistors. Free Bargain List. Eric Supply, 88 Exchange Street, Rochester, N. Y.

**COILS**

Superhet matched kit: 1st I.F.; 2nd I.F., Osc. and Loop Antenna. With circuit diagram. Postpaid in U.S. **\$1.95**

**C-B Manufacturing Co.**

412 W. 37 St. New York 18, N. Y.

bakelite tubing are connected to the hot microphone and transmitter leads, forming slip rings which contact brass brushes at the base of the assembly. A pointer is also mounted on the shaft, and indicates direction on the compass rose which can be seen on the cabinet top.

The transformer which supplies power to the transmitter is specially-wound, and is about the size of a large audio

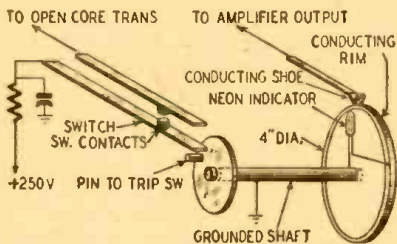

Fig. 3—Synchronized slip-ring and switch.

transformer. The experimental set operated from a 6-volt battery and vibrator pack, and used an old time filament rheostat as "off-on" switch and gain control.

The Sonicator is an invention of Leslie Gould, of Greenwich, Connecticut, who has two patents pending on it. Mr. Gould, who is well known to readers of RADIO-CRAFT through his items on new electronic musical instruments, FM phono pickups and other inventions, believes that his latest creation will cost no more than a medium-priced radio, and will be no more difficult to operate.

### WAVE SHAPING CIRCUITS (Continued from page 761)

part of the increase of the instantaneous input voltage above the cathode bias voltage. It is then quite evident that for the period of time that the instantaneous voltage rises above the value of  $E_c$ , the effective grid voltage will be held at approximately zero as indicated in periods 1 to 2 and 5 to 6 in Figure 2-c.

While the effective grid voltage is held at zero, the plate current will be a constant at its maximum value, and the output voltage at the plate will be a constant at its minimum value.

For the time that the negative swing of the input voltage brings the effective grid voltage below cutoff, the plate current flow is constantly at zero. This holds the output voltage constant at its maximum value. This is indicated in periods 3 to 4 and 7 to 8 in Figure 2-c.

By shifting the value of the cathode voltage, the amplitude of the square wave output and the steepness of its sides may be controlled.

100-Watt Vasco Soldering Iron.....	\$3.30
Hi Freq. Buzzer, 2 to 4 volts DC.....	.79
Midget 100 MMFD Variable Condenser....	.79
5-Inch P.M. Speaker.....	1.77
300-Ohm Amphenol twin lead per 100 ft. . .	2.90
75-Ohm Amphenol twin lead per 100 ft. . .	2.00

Complete line of B. & W. Coils.  
Sales in Calif. add 2½% sales tax

**DOW RADIO**

1759 E. Colorado Pasadena 4, Calif.

# NOW you CAN afford an OSCILLOSCOPE!

For The Service-Man, The Engineer, The Amateur, The Experimenter

## The POCKETSCOPE

- So SMALL in size (4" x 6¾" x 10")
- So LIGHT in weight (5¾ lbs.)
- So COMPLETE in performance
- So INEXPENSIVE in price
- Plus WIDE-ANGLE VISION: on shelf, on floor, on bench
- Plus RETRACTABLE LIGHT SHIELD: for increased visibility

A 2" "pocket-size" 'scope incorporating the cathode ray tube, vertical and horizontal amplifiers, linear time base oscillator, synchronization means and self-contained power supply.



FOR DELIVERY

Contact your nearest jobber. If he doesn't have the POCKETSCOPE available, contact us direct.

**WATERMAN PRODUCTS CO.**  
INCORPORATED  
Phila. 25, Pa.

**WATERMAN PRODUCTS**

## World Radio Leads in SAVINGS



### 40 WATTS INPUT — WRL GLOBE TROTTER TRANSMITTER KIT

Complete including all parts, chassis panel, streamlined cabinet, less tubes, coils, and meter. Cat. No. 70-300. **\$59.95**

Cat. No. 70-312 Kit same as above wired by or engineers ..... \$75.00  
All necessary accessories ..... \$13.85 Extra

Here is the latest most outstanding transmitter value on the market today. Capable of 40 Watts input on C.W. and 25 Watts input on phone on all bands from 1500 KC through 28 Mcacycles. Incorporates Tritet Oscillator using a 20 meter X-tal, three bands; 10, 20, and 80 meters; two power supplies.

### FREE! RADIO PARTS FLYER

Send for your copy today. Page after page of real savings in radio, electronic and general merchandise.

Giant Radio Reference Map 15c Tube Base Calculator .... 25c



Formerly Wholesale Radio Laboratories  
Address Dept. RC-8, Council Bluffs, Iowa

## —Special!—

Make any record player wireless with these brand new

### TWO-TUBE PHONO OSCILLATORS

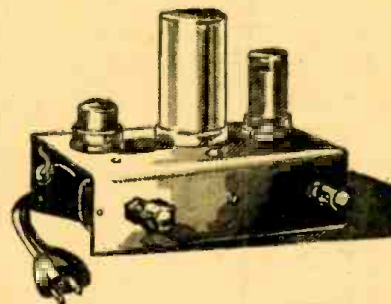

Operates as far as 100 feet from a radio and can be used with Automatic Record Changers, Players or Microphone. Uses 1-12SH7 and 1-12H6 Tubes. **\$8.75** Complete with tubes net

Supplied in kit form with "easy-to-follow" instructions for assembly. Complete with all parts, instructions and tubes **\$5.95** net

Send for FREE BULLETIN

## D. & D. RADIO

160 Duane St. Dept. C New York 13, N. Y.  
COrtlandt 7-0371.



# OLSON

## OHM CHEST

packed with  
100 Insulated Resistors

A tremendous value! This handsome Chest has twenty compartments—10 in the base and 10 in a removable tray. Walnut finish; brass hinges and fastener. Contains 100 resistors stamped with resistance values, 5 ohms to 20 megohms, 1/2 watt to 2 watts, color coded. Every size is popular. No war surplus resistors in this Ohm Chest!

**only \$4.95**  
complete POSTPAID

ORDER NOW for immediate delivery.

**Free!**



With each Ohm-Chest ordered, we send our "Resist-O-Guide" free. Revolving wheels in color show all resistance values.

**CLIP AND Mail today!**

This offer good only in U. S. A.

Write for our monthly BARGAIN CATALOGS—they're free!

**OLSON RADIO WAREHOUSE**  
73 E. Mill St., Dept. 36, Akron, Ohio

Send me \_\_\_\_\_ Ohm-Chests with 100 Insulated Resistors in each; @ \$4.95. "Resist-O-Guide" free with each Chest. I enclose \$ \_\_\_\_\_  Send C. O. D.

NAME \_\_\_\_\_

ADDRESS \_\_\_\_\_

### A Simple Transitron

HERE is one of the simplest and most stable types of oscillator which can be constructed. Besides power supply, only five components are required: pentode tube, socket, resistor, condenser and pair of phones. The power input is very small and the output is a pure sine wave, containing no trace of distortion as observed on an oscilloscope.

The circuit is a transitron. Experiments were carried on with a type 6J7 as a typical pentode, but any other type, preferably the miniature styles, can be used. The condenser and resistor used may be of low rating and small size since the voltages used are low.



This low-voltage transitron audio oscillator produces a pure sine-wave note at 800 cycles.

Following are combinations of voltage inputs used and the output voltage measured across a pair of phones:

Plate	Screen	Output
3	4.5	.1
3	6.0	.4
3	7.5	.6
7.5	7.5	1.4
1.5	25.0	8.0

At the lower values listed the cathode current is approximately 200 microamperes. The pure sine wave is obtained when using the first three listed conditions. The higher the voltages the greater the distortion.

In general the transitron requires a higher voltage on the screen than the plate, but note that oscillations were obtained with 7.5 volts on each.

The note obtained depends upon the impedance of the phones and the voltages applied. It may also be changed to some extent by shunting the phones with a condenser, but it was found that at very low voltages, the tube went out of oscillation when a large capacitance was connected. A frequency of 800 cycles was obtained.

This source of low-power, audio-frequency oscillation should be excellent for bridges, testing and code oscillator work. If more power is needed, the output of this oscillator can be amplified to any desired level.—I. Queen

**IMMEDIATE DELIVERY!**

APPROVED Model A-100  
**SIGNAL GENERATOR**



- 6 R.F. BANDS  
100 Kc.-310 Kc., 310 Kc.-1000 Kc., 990 Kc.-3200 Kc., 3200 Kc.-10.6 Mc., 10.6 Mc.-29 Mc., 21.2 Mc.-52 Mc.
- CONTINUOUSLY VARIABLE RF-AF fine attenuator control.
- EXTERNAL MODULATION FROM 40 to 30,000 cycles.
- INTERNAL MODULATION AT 440 cycles.
- NEGLIGIBLE HARMONIC OUTPUT.

Net Price . . . \$47.00

—Circular on Request—  
C.O.D. orders should be accompanied by 25% deposit.

**SCENIC RADIO & ELECTRONICS CO.**  
53 Park Pl., New York City 7

famous for  
**GREAT VALUES**

Outstanding Offerings of  
**NEW KITS!**

**6 Tube SUPERHET KIT** — Two band complete with tubes and solid color (green, red, ivory, etc.) wood cabinet. Includes all parts, except wire and solder . . . . . **\$18.50**  
Per Kit

**PHONO KIT** Consists of AC Phono-Motor, Pick up, all parts necessary for 3 tube phono Amplifier, including 5" P.M. speaker. Excludes wire, solder and tubes . . . . . **\$16.25**

With the Above { PA-12 portable leatherette-covered all-wood cabinet . . . . . **\$7.95**  
Kit of tubes . . . . . **\$1.85**

All prices are F.O.B. New York City.

Write for our new catalogue showing new test equipment, tubes and a large variety of new replacement parts. We ship anywhere in the U.S.A.—promptly.

**RADIO DEALERS SUPPLY COMPANY**

135 LIBERTY ST., NEW YORK 6, N. Y.

Order from LAKE!  
You'll Make No Mistake!  
**RADIO Cabinets & Parts**



**NOW Available**  
Postwar  
2 Post  
**RECORD-CHANGER**

With luxurious brown leatherette portable case 15" L x 15" W x 10" D. Latest electronic developments make this modern record-changer the finest on the market today!

List Price . . . \$49.95 Dealer's net . . . \$29.97

Also blank table cabinets of walnut veneer in the following sizes, with speaker opening on left (front side). (Note: 7" has center speaker grill.)

21	8 1/2" L x 5 1/2" H x 4" D	\$1.95
22	10 1/4" L x 6 3/8" H x 5" D	\$2.75
23	13 1/2" L x 7 5/8" H x 6 1/4" D	\$3.25
27	10 3/4" L x 7" H x 5 1/2" D	\$2.50

\*Speaker Opening in center of front side.

All types of radio cabinets and parts are available at Lake's lower prices. A large stock is listed in our catalog.

**SERVICE MEN—RETAILERS**  
Join our customer list today.

Order our New Catalog Today!  
Get on our mailing list!

Dist. C

**LAKE RADIO SALES CO.**  
615 W. Randolph Street, Chicago 6, Ill.

**WIRELESS PHONO OSCILLATOR**

**NO LICENSE REQUIRED**

Transmits recordings from phono pickup or voice from carbon mike to radio without use of wires up to 500 ft.

Complete Kit with tubes . . . . . **\$6.50**  
Above Kit assembled and tested . . . . . **7.95**

Immediate delivery  
**CONSTANT ELECTRIC**  
112 Cornelia Street Brooklyn 21, N. Y.



## THE CASE OF THE EMPTY SOCKET

SOME time ago a member of the Merchant Marine brought me his four-tube (6SK7, 6SJ7, 25L6, 25Z6) a.c.-d.c. radio to repair. Trouble was due to a burned-out ballast tube. I had no ballast tube, but did have a line cord, which did the job. For appearance's sake I left the old ballast tube in the socket, and that was that. Everyone satisfied and happy.

But this morning, for some unknown reason, I got to wondering what would have been the best thing to do if the customer had wanted the ballast tube socket used to add a fifth tube to his radio.

The sketches to the right show the three uses to which an extra tube could have been put:

1. Resistance-coupled r. f.
2. Resistance-coupled detector.
3. Resistance-coupled first a.f.

Just wondering which would have done the most good.

To the best of my knowledge the radio is now on the high seas. Besides, all I was paid to do was replace the line cord.

If and when I have to handle this problem again I

think I'll know how to handle it. But this might be interesting for RADIO-CRAFT readers. Which is most efficient?

Obviously, as only the present two-gang condenser is available—and we ain't changing this to a superhet!—there's little or nothing to be done about improving selectivity. Resistance-coupling helps gain, but not selectivity. (I bet you knew it all the time!)

—N. H. Silverman

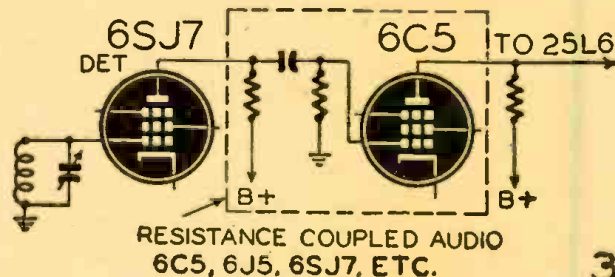
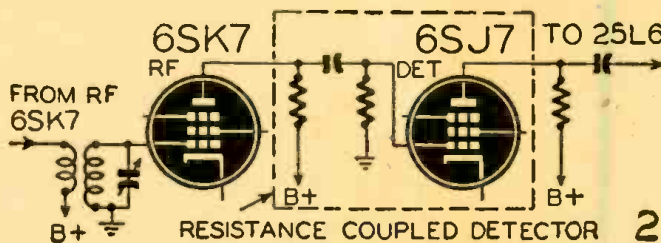
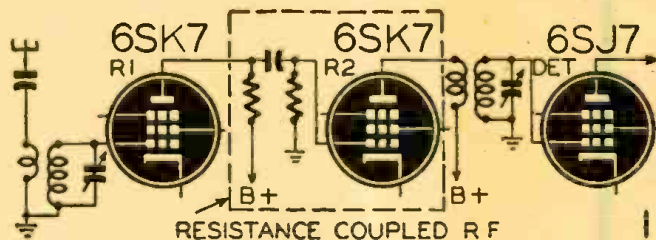

## RADAR WAS GOOD GUN-RANGING EQUIPMENT

Radar equipment intended primarily for use against enemy aircraft was also highly valuable in ground fighting, the *Coast Artillery Journal* revealed last month.

Early in the development of radar, it was discovered that it could detect and track shells fired from mortars and field artillery pieces. This knowledge was put to good use in finding well-concealed enemy batteries by tracking the shells they fired. American shells sent back along the same courses silenced the batteries.

Special shells were made for radar ranging and for correction of gun ranges, it has been learned from other sources. Each shell contained a bundle of wires cut to the frequency of the radar transmitter. The bursting shell threw into the air what were in effect a large number of dipoles tuned to the radar frequency. The resulting large echo was easily identified and the exact position of the shell burst could be noted. Corrections then made the

next shell land square on top of its target.

It was also found possible to detect and track enemy tanks, mobile guns and even moving bodies of troops. To do this, it was necessary to modify the radar so that it would filter out echoes from stationary objects and register only the echoes from things that moved.

## 500 FORMULAS TO SUCCESS

MANY million dollar firms started with a single formula, for which they paid a big price. Here you have 500—no less—tried and tested formulas, recipes and processes for making things—all at the ridiculously low price of 25c. Here is your opportunity to start a business with but a few dollars' capital and with undreamed of profits in prospect. You can also use these formulas in your own home to cut household expenses to the bone. Or you can put them to use in your workshop to cut costs as much as 1000%. Quit paying out many dollars in profits to manufacturers, wholesalers, and dealers, when you can make the same thing yourself for a few cents. It's so easy when you follow our simple instructions.

66 PAGES, 3200 WORDS IN TEXT  
Send for "500 FORMULAS AND RECIPES" to-day. Enclose 25c, that's all! You won't be asked for another cent now or later. Sold on a money-back guarantee.

**NATIONAL PLANS COMPANY**  
P. O. BOX 26, K STATION N. New York 23, N. Y.



## OSCILLOSCOPE FOUNDATION KIT

5 INCH

Consisting of: Case, Chassis, two shelves (right & left), tube shield and bracket, front panel, screen window frame, handle, plastic window socket, with 5CP1 Cathode Ray tube—Special \$18.95



KIT, without Cathode Ray tube 11.95  
5CP1 Cathode Ray tube only 7.40  
Tube shield and bracket only 1.98

**HIGHBRIDGE RADIO-TELEVISION AND APPLIANCE CO.**

340 Canal Street New York 13, N. Y.

## Selsyn Control Transformers and Generator

in pairs, 57.5-57.5 volts, 400 cycles, with caps adaptable for rotary beam indicators, \$4.95 a pair postpaid.

**LYELL HARDWARE & LUMBER CO.**

P.O. BOX 13 ROCHESTER 11 NEW YORK

## BUILD YOUR OWN RECORD PLAYER

DETROLA AUTOMATIC CHANGER—BEAUTIFUL CABINET—AMPLIFIER AND SPEAKER.



Newest in Design—Footproof, Plays 10" or 12" Records. Your cost net \$18.27 Changer only

Cabinet made to fit Changer Amplifier and 6" Speaker. Cabinet only net \$4.95



Amplifier AC 3-Tube complete with tubes and 6" Speaker. Can be installed in 30 minutes. Your cost net \$12.95

Be sure to send name for new free low price circular.

**McGEE RADIO CO.**

1330 BROADWAY, DENVER, COLORADO

## THE BUY OF A LIFE-TIME!

### BRAND NEW GENUINE U. S. SIGNAL CORPS

SHORT-WAVE TRANSMITTERS

72.2 M.C. Approx. 5 meters

COMPLETE WITH TUBE

Operates on 1 Dry cell 1½ volts—87½—90 V.B. Ready to use—attach di-pole—antenna—keying or mike—connect batteries and you have it. Wired with silver wire, silver mica condensers, precision resistors, acetate socket. Circuit is completely stable and has low loss silver wire inductance (adjustable padding). Guaranteed to work, and it weighs less than 1 lb.

This outfit can be converted easily into a walkie-talkie. Schematic diagram furnished. No C. O. D.

Express Shipments only. Sacrificed at \$2.95—Postal or Express Money Order or Certified Check. **NEWARK SURPLUS MATERIALS CO.** Newark 2, N. J. 324 Plano St.

# "TAB"

That's a Buy



## "TAB" Special

Navy TBY portable ultra Hi-Freq. 28 to 80 mc's transceiver Voice & CW Spot calibrated, including crystal calibrator, all tubes, adj. ant.; phones, mike, carrying case \$49.50.

Additional spare parts. Vibrator supply. Trunk. Antenna, manual and other spares \$25.00.

- DC-9A1 Crystal Std. 1000Kc G' Insp. S.C. \$ 5.95
- Stono Carborundum dual grit (LP \$1.70) 3 for 1.00
- G.E. Pyranol 2 mfd 400V wkq. (LP) \$55.00 4.95
- New W.E. Beachmaster Amplifier Navy Parts
- New W.E. Dynamic microphone D-173340A Complete with 50' cable, desk stand or chest plate, feedback reduction attachment, freq. range 50 to 9000 cycles "TAB" Special... \$11.95
- With W.E. input mike trans. KS-9450..... 13.95
- Dynamic mike cartridge only D173127..... 4.95
- All 3 units Mike. Transf. re. Cartridge..... 18.00
- W.E. pp. inpt. tnsf. 100-10000 cy-KS-9448..... 2.50
- W.E. pp. input driver 6V6's to pp. 805 grids freq. 100-10000 cy Tnsf KS-9449..... 4.50
- Both units KS-9448 and KS-9449..... 6.50
- W.E. Vacuum Time delay fil Relay 115V-AC..... 1.49
- W.E. Oil Cond 4mfd 400V wkq. Two for..... 1.00
- Sprague Oil Cond. 4mfd 1500V wkq. Two for 4.50
- CD T1H Oil Cond 6mfd 1500 wkq. Two for 5.95
- Punched chassis 16 1/2 x 4 1/2 @ 35¢ 16 1/2 x 13 x 2" 65¢
- Solar 25mmf. Con. 10000V wkq UHF ins..... .35
- Switch 10 pos. Ceramic Xmitting HV&CUR..... .97
- GR VARIAC 200-CUS 0-130VAC860W LN (S24)..... 13.95
- Allied Relay BJ 115VAC DPDT 5AMP cts New 1.49
- Allied Relay BO 5000 ohm DPDT 10AMP cts New 1.92



Raytheon 866A filament transformer 115V 60c pri. 2.5Vct 11A Sec and Two new RCA 866A tubes \$5.90 With Millen caps & sockets 7.00 Raytheon Transformer only 3.25

### Transformer High Voltage

Kenyon like New 115V-60 Cy. Sec. 3200V no C. T. \$ 9.00

For that California Killowatt. For single or P. P. 304TL tubes Two units 6400V C. T. wt. 60 lbs. 16.00

- WE tnsf 115V60cy pri-V26A sec 15000V ins. 4.50
- Condr Sprague Oil 10mfd660VAC2000VDCwkq 2.70
- Condr G.E. Pyranol 15mfd660VAC2000VDCwkq 3.90
- Condr F31-822 Bangamo 002mfd800V(LP332) 3.99
- Condr G.E. 3 mfd 330V AC-1000V DC 3MFD-330VAC-1000VDC 2.50
- Condr OH & Insulators 2 mt 2000V DC 2 MFD-2000V DC 4.25
- New 6AC7/1852 JAN S.C. tubes..... 65¢
- G.E. 872A new JAN S.C. (LP750)..... 4.50
- Pilot Lamp Mazda 49 G.E. 2V.06A..... 10 for .50
- BC-412 Sweep ckt Scope Conversion KIT..... 15.75
- AC Voltmtr Watshe 150V 2 1/2 BC G'1..... 1.98
- WE Silver micas .02461, .01644, .0490..... 3 for 1.00
- WE 115V 60 Cy pri. 650V CT. 300 Ma. 5V3A 6V5A, hermetically cased, wt. 19 lbs..... 3.95
- Crystal any freq. mtd 2-10mcs ea. \$1.51. 4 for 5.90
- WE Crystal IN21-22-23 new lead sealed 3 for 1.50
- Resistor Kit 100 BT's & W. 50 to 2 megohms..... 2.50
- Mica Condr Kit-gty Silvermica..... 50 for 2.00
- Autosyn Bendix Xmitter & Revr. new G'1..... 2.95
- Autosyn Bendix Hobart 115V-60 Cy, New 2 for 18.00



Complete New Code practice set in trunk McElroy AN/GBC-TI operates on 6, 12, 24, 115V DC & 115, 230 VAC for classroom, camp or club Code practice, gives both visual, blinker and audio adjustable freq. tone. Loud speaker also earphones connection. Room for phones and keys out-put good for at least 100 students. Brand new G'1 Insp. Power supply with two Vibrators worth the price alone.

G'w't cost \$197. TAB special \$22.50. New S.C. 138 Keys 98¢. Headphones W.E. 509 Hi Imp. 8' CD & PLG \$3.95 S.C. Headphones with rubber cushions \$1.90.

\$1 Min. orders FOB N.Y.C. Add Postage all orders and 25% deposit. Whitehall 3-3557. Send for catalog 500. Don't wait, rush orders as quantities are limited. Buy thru "TAB" and save.

"TAB," Dept. RC8

6A Church Street, New York 6, N. Y.

# COMMUNICATIONS

## A BRICKBAT

Dear Editor:

'Tis with sorrow that I pen this "brick-bat" when I look back over the years to 1919 when your former *Radio News* was in its glory.

WHY, Oh! WHY? ? do you cater to the mathematical self-styled "wizards" of radio, when they are out-numbered by at least 1000 to 1, by the radio experimenters?

As one of your readers in the June issue expresses it, "Couldn't you give us a few SIMPLE articles, now and then?"

That expresses it better than I could, if I used many pages of good white paper.

I have only a small business with a little over 20,000 customers scattered all over the world, and I venture to assert that NOT 1 PER CENT of them could understand the articles that you ARE NOW printing in your magazine, RADIO-CRAFT.

Many of my customers have bought ONE COPY of RADIO-CRAFT and they never bought another one, BECAUSE they are not "Radio-Engineers" and they look thru the pages in vain, for something they could build.

LESLIE HULET,  
New York, N. Y.

## AND A BOUQUET!

Dear Editor:

Please continue your excellent articles on modern developments in Radio and allow the professional technician a fair share of your columns. There must be many like myself who rely on such excellent magazines as yours for their preview of things to come. To us the Magnetron and similar new devices are things of importance, and I would say to Mr. Laporte of Worcester, "Don't be greedy, please!"

H. F. LESLIE,  
Burnham-on-Sea,  
Somerset, England

## LIKES NEW TECHNIQUES

Dear Editor:

RADIO-CRAFT has been my principal source of information since the day I first began servicing radios. As a repairman, I naturally find articles on servicing and test instruments and the departments dealing with the subject most interesting. I miss the *Technotes* which have not been included in some recent issues.

Some of the criticisms you receive border on the idiotic. One of the latest (in the April issue) suggests that you should forget about radar, loran, etc., and "throw them out the door!" Why don't these narrow-minded readers stop to ask where our ocean and air trans-

# 18 YEARS IN RADIO

GET THIS  
New CATALOG  
By This Old Firm



Latest developments in radio and electronic parts and devices, newest ham gear, gadgets for experimenters, bargains in war surplus items.

FREE  
TO YOU

Mail the coupon below and get this new catalog FREE.



BURSTEIN-APPLEBEE CO.,  
1012 McGee, Kansas City 6, Mo.

Send me FREE catalog advertised in Radio Craft

I AM \_\_\_\_\_  
STATE CONNECTION IN INDUSTRY \_\_\_\_\_  
NAME \_\_\_\_\_  
ADDRESS \_\_\_\_\_  
TOWN \_\_\_\_\_ STATE \_\_\_\_\_

# SCOOP!

RADIO SERVICEMEN  
HAMS — EXPERIMENTERS

MINIATURE EXTRA SENSITIVE HEADPHONES  
Still Available - Limited Quantity

- Signal Corps Type HS 30 and matching transformer. Complete ..... Net \$3.49
- RESISTOR KIT—50 assorted 1/2 Watt insulated resistors—RMA..... 1.19
- CONDENSER KIT—Mica—Popular sizes —standard brands..... 12 for .59
- SPEAKERS—5" PM Alnico V..... 2.29
- CATHODE RAY TUBE—3BP1—Brand New..... 5.95
- SUPERHET COIL KIT—2 I.F. coils (455 KC) 1 oscillator coil and loop to match Complete..... 2.29

## ELECTRONIC SUPPLY CORP.

DEPT. A, 4014 GREENPOINT AVE.  
LONG ISLAND CITY 4, N. Y.  
Stittwell 4-0231

## If It's a CANNON-BALL

It is a  
GOOD HEADSET



Scientifically built Heavy bar magnets greatly increase their efficiency.

For clarity of tone use Cannon-Ball sensitive phones. Assure dependable performance. Guaranteed to give absolute satisfaction. Write Headset Headquarters for folder R-8 illustrating complete line.

C. F. CANNON COMPANY  
SPRINGWATER, N. Y.

NOW! A RADIO SET THAT ANY BOY CAN BUILD



only \$3.49 A workable radio receiving set any boy can build. Kit complete with diagram, parts, instructions and standard earphones. Get the youngster interested in radio with this simple crystal set. He'll be thrilled to see it work. Sent C.O.D. plus postage, or send \$3.49 and we pay postage.

Disco Sales, Inc., Dept. RC1, 154 Nassau St. N.Y. 7, N.Y.

## TWO MORE STUPENDOUS BARGAINS IN SURPLUS RADIO NOW AVAILABLE!

In line with our past policy of being "The first with the best for the least," we announce two more of our bargains in government surplus electronic equipment. These two were procured after a careful survey of many different types of equipment available, and selected on the basis of their ease of adaptability to civilian use, for their conventional design, and most of all, to avail our customers of the greatest saving in dollars and cents that is possible.

The first is the famous BC-654 transmitter and receiver, also known as the SCR-284A. This set consists of a 7-tube superhet receiver, and a 25 watt transmitter, constructed on separate chassis, and mounted together in one cabinet. Designed especially for semi-portable and vehicular operation, weighing 45 lbs., and operating on phone or CW from 3780 to 3825 Kc, this set is a "Natural" for amateur use, for aircraft, marine, police, as well as for experimental and instructional purposes. Due to its construction, it is very easy to adapt this equipment to operate on other frequencies.

The receiver employs an RF stage, a mixer-oscillator stage, two 455 Kc. IF stages, a second detector, and two stages of audio amplification. Also featured are AVC, a beat frequency oscillator, and a high-ratio geared vernier dial drive. Due to the low drain tubes employed, the receiver operates from small portable batteries (1½V and 90V). A small electronic supply may be used, and operated from 110V, or 6 or 12 volts DC. Either a speaker or headphones may be used in the output circuit.

The transmitter consists of a stable, thermal-compensated electron-coupled oscillator, a buffer, and a

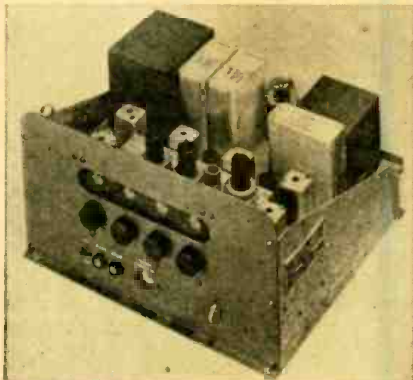
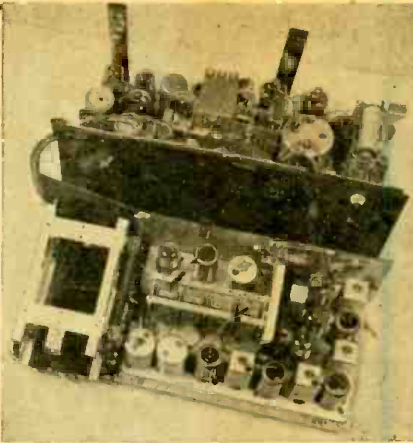

pair of 307-A or 8K-75 class "C" power amplifiers. Two more tubes comprise a modulator and a 200 KC crystal calibrator circuit. This calibrator insures crystal accuracy in transmitter oscillator setting. A built-in antenna tuning circuit, including a thermocouple R.F. ammeter matches the transmitter to a wide range of antenna lengths. The transmitter requires 6 or 12V filament voltage, 45 volts bias, and 500V plate supply. These voltages may be obtained from a 110V power supply, or from the dynamotor described below.

These sets have been slightly used, but outside of scratched cases, are in "like new" condition, both electrically and mechanically. Each set includes circuit diagrams, instructions, crystal, and a complete set of 13 tubes.

Also available is a dynamotor unit (PE-103) which was designed especially for this equipment. This unit operates from 6 to 12V D.C. and delivers 500V DC at 160 MA. Its base contains filters, circuit-breakers, switches, and relays necessary for operation, and is supplied complete with cable.

The price of the complete set is \$39.95. A dynamotor, if desired, is \$19.95. Both units purchased together, \$54.95.

Our other special is one of particular interest to those who are working on Ultra-High frequencies. This is a Pi-tube receiver, operating from 157 to 212 Megacycles. All controls and illuminated tuning dials are on the front panel. Dimensions are 15x16½x9", and shipping weight is 75 lbs.

This fine piece of equipment, which is complete except for phone or speaker, plugs right into any 110V 60 Cycle line, has 2 RF stages, a 9006 first detector, a 6J5 oscillator, FIVE IF stages, using 6AC7's and 6AB7's second detector, two audio stages and a 6E5 tuning indicator. This receiver is typical of the kind of equipment recently used to receive reflected radar signals from the moon, and undoubtedly is far more sensitive than any set used by anyone not previously engaged in similar work. Government cost was almost \$700. While our limited quantity lasts, your cost for this super bargain, complete with tubes, is \$39.95.

**RECORD CHANGERS**, 110V 60 cy. With crystal pickup. This modern two-post changer plays twelve 10 or 12 inch records **INTERMIXED!**—The only changer on the market with this feature, in its price range. Now specially priced at \$24.95 including blue leatherette case.

10% Deposit must accompany all C.O.D. orders.

# BUFFALO RADIO SUPPLY

219-221 GENESEE ST., DEPT. SC, BUFFALO 3, N. Y.

portation would be now if radio were thrown out the door in its infancy?

JOHN W. FINDLARE,  
Modesto, Calif.

(RADIO-CRAFT is glad to print as many good Technotes as it can obtain, but does not receive enough to run them every month. It is up to our servicemen-readers to correct this deficiency! A six-month subscription is given for every Technote printed.—Editor)

### A SOUND ENTHUSIAST

Dear Editor:

As a shut-in, I await RADIO-CRAFT impatiently each month. I have read it for many years and it gets better year by year. I like especially your construction articles and the *Radio-Electronic Circuits*, *Question Box* and *Try This One* departments. I am especially interested in articles on amplifiers and would like to see A. C. Shaney writing again for you.

Being a shut-in, I'd like to hear from your readers on radio construction, especially those who are interested in the faithful reproduction of music. If they have any pet circuits, I would appreciate receiving them and trying them out. My interests extend to high-fidelity amplifiers, bass-booster circuits, baffles, tone equalizers, FM and AM tuners, expander-compressor circuits and recorders (especially wire recorders).

I read an article by Winton Walter in your sister magazine, *Radio and* (Continued on page 800)

## MORE SMASH BUYS at National Radio Distributors

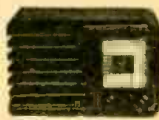

### IMMEDIATE DELIVERY

5 Tube AC/DC Superheterodyne Radio Kit, featuring built-in loop antenna, automatic volume control and uses 12SA7, 12SK7 12SQ7, 50L6, and 35Z5 tubes. All parts brand new and perfectly matched. Complete including high polish brown plastic cabinet and instructions for easy assembling. Less tubes. Approx. size 9" x 6" x 5".

.....	Net \$13.75 each
In lots of 3.....	Net \$12.95 each
Kit of matched tubes for above.....	\$4.95 each



### PORTABLE RECORD PLAYER KIT

consists of handsome brown leatherette portable carrying case, new heavy duty alliance or G.I. type piano motor and turntable, astatic crystal pickup arm, 3 tube completely assembled AC/DC phono amplifier (using 12SQ7, 50L6 and 35Z5 tubes, featuring separate tone and volume controls), new Alnico speaker and output transformer. Approx. size complete unit 17"x12"x7½". Will play 12" record with lid closed. Complete less tubes.....\$24.75 each  
Kit of 3 matched tubes for above.....\$2.95 each

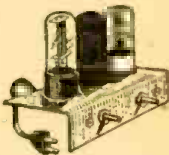

### 3 Tube AC/DC Phono Amplifier

—uses 12SQ7, 50L6 and 35Z5 tubes. Completely assembled and ready to operate. Approx. size 5½"x8¼"x1¼"

Less tubes.....	Net \$4.55 each
Lots of 6.....	Net \$4.25 each
Kit of 3 matched tubes for above.....	\$2.95 each

25Y5 Radio Tubes—Direct replacement for 25Z5 tubes. Fully guaranteed.....List \$2.35  
Your Net \$1.46 each

Please remit at least 25% with all C.O.D. orders  
Write for Complete New Catalog NOW

## National Radio Distributors

1029R E. 163 St., New York 59, N. Y.

# RADOLEK

## Radio-Electronic Service Parts



Large stocks assure the finest and most complete selections of all available items at lowest prevailing prices. Thousands of active buyers depend on us for their entire Radio repair and replacement requirements. Because we understand service problems, every order is expedited for delivery in double quick time. Everything we do is planned for convenience and satisfaction to our customers. You will find it profitable to make Radolek your buying headquarters.

### FREE BUYING GUIDES

Because of existing conditions we keep our customers right up to the minute on available merchandise by releasing supplements frequently instead of sending our regular Big Profit Guide once a year. Send the coupon now to get these Free Buying Guide Supplements as they are issued.

FREE!

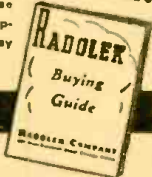

### FAST SERVICE!

RADOLEK CO., Dept. C-117  
601 W. Randolph St., Chicago 6, Ill.

Please send FREE Buying Guide Supplements

NAME \_\_\_\_\_  
ADDRESS \_\_\_\_\_

### ORDER FROM RADOLEK

# Portable A.C. Ammeter

Government Surplus New  
Weston Model 528



Dual Range 0-3 Amp. and 0-15 Amp. full scale. For use on any frequency from 25 to 500 cycles. The ideal instrument for all commercial, industrial, experimental home, radio, motor, and general repair shop testing. Comes complete with a genuine leather, plush-lined, carrying case and a pair of test leads. A very convenient pocket-sized test meter priced at less than 50% of manufacturer's list.

Your Cost **Only \$12.50**

## VARIACS



General Radio Type 200 CU, 860 Volt-Ampere rating, 115 Volt A.C. Input; 0 to 135 Volts A.C. Output maxim current of 7½ amperes. Shipped complete with knob, less dial, in original G. R. carton.

**Only \$12.00**

## MARITIME SWITCHBOARD

336 Canal St., New York 13, New York  
Worth 4-8217

## TRANSMITTER OUTPUT STAGE

(Continued from page 755)

operation of the amplifier on its proper frequency, but presents just enough suppression to the parasitic oscillations to eliminate them altogether.

### AMPLIFIER NEUTRALIZATION

This is very simple if the following method is followed: First, make certain that you have a sufficient amount of bias on the grids of the TW-75s. A "fixed" bias of about 135 volts negative from either B batteries or a bias pack is recommended with the remainder obtained from the drop across the gridleak.

Adjust the swinging-link coil until the grid current to the tubes is about 60 milliamperes with the grid circuit tuned to resonance and *with the tube filaments lighted but the plate voltage removed*. Never try to neutralize and adjust the excitation to an amplifier with the plate voltage on! An accurate adjustment is impossible and the tubes are almost certain to be damaged. Once the proper grid current is obtained and the grid circuit tuned to the peak of resonance, rotate the plate tank condenser through resonance, watching the grid milliammeter. At the point of resonance there should be a violent kick of the grid milliammeter needle and a neon lamp touched to the plate tank will indicate r.f. voltage on the coil.

Now adjust each neutralizing condenser in turn, rotating the plate tank condenser through resonance again and again, until there is no movement of the grid milliammeter needle and no indication of r.f. voltage on the plate tank coil when touched by the neon lamp *at any setting of the plate tank tuning condenser*.

After this is accomplished, apply the plate voltage and tune the plate circuit to resonance as indicated by the usual dip in plate current.

The loading of the antenna from the swinging-link plate tank coil is very simple. A number of effective coupling methods are shown in Fig. 2. If a simple half-wave doublet, with a low-impedance line, is used, the loading can be varied by merely adjusting the swinging link and keeping the plate circuit retuned to resonance, until the desired power input is obtained.

In the tuned-coupler systems the swinging link should be pulled out approximately half way and the antenna condenser adjusted for resonance. Try to obtain the maximum loading of the antenna with the link as far out as it is possible to secure sufficient coupling. Once the resonance point is located it is a simple matter to adjust the loading for power input, by pushing the link toward the coil. If the antenna and feeder impedances are properly matched, loading of the antenna by changing the position of the link will not detune the final amplifier plate circuit.

In actual practice, the tuning should be checked every time an adjustment is made; a perfect match in the average

# SENSATIONAL VALUE at RADIO ELECTRIC!

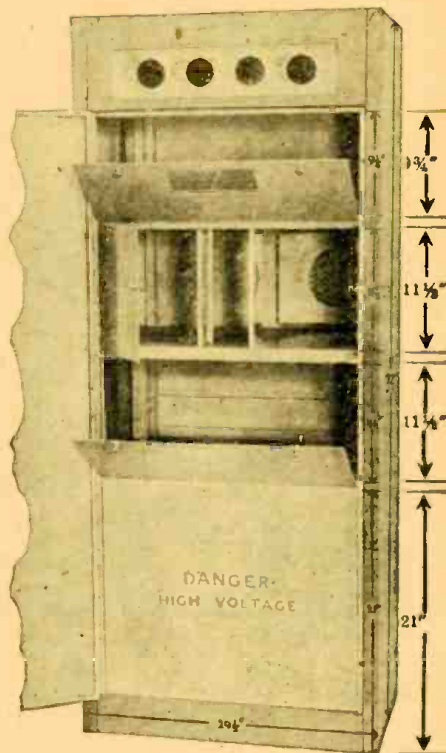

U. S. GOV'T. SURPLUS

## CABINET

#16 gauge steel, gray crackle finish, scratch proof. Adaptable for master installations for broadcasting, amateur, sound. Ideal for school, hospital, industrial and commercial institutions. Specs.: Height 72", Depth 24 3/8", Width 29 1/2".

**ONLY \$79.95**

\* IMMEDIATE DELIVERY on Radio and Electronic supplies. Send for FREE FLYER today—describing unusual values in all radio parts and equipment.

\* DISTRIBUTORS OF WASHER AND VACUUM CLEANER PARTS.

MAIL ORDERS SHIPPED IN 24 HOURS

## RADIO ELECTRIC

SERVICE CO. OF PENNA. INC.

N.W. COR. 7th & ARCH STREETS, PHILA. 6, Pa.

STORES ALSO IN

Camden, N. J.  
Wilmington, Del.

Allentown, Pa.  
Easton, Pa.

Our EXPORT DEPT. Circles the Globe

## Civilian Radio Jobs Wanted

FREE WANT-AD SERVICE

By Former Soldiers, Sailors, Marines

Radio-Craft offers its help-wanted columns free for the use of honorably discharged men in the armed services. State the type of position you seek, preferred locality, your experience, education, and other details. Confine ad to 50 words, or less. Supply name and address. Army veterans send section number or photostat of discharge paper. Navy men send photostat of discharge paper. Address RADIO-CRAFT, Classified Ad. Dept. 25, West Broadway, New York 7, N. Y. Your ad will contain a box number and replies will be forwarded to you.

**RADIO TECHNICIAN** 1/c; Red-Telo; 1 yr. coll. A Fortunato, 240 E. 19th Street, New York 36.

**RADIO**—Part-time mornings; Air Force trained; radar grad; attending school aft. S. Altman, 1110 Colleke Avenue, Bronx 56.

**RADIO TECH.**, 2/c; radio tel.; 3 yrs. coll.; married; teaching exp. G. Bell, 1606 Avenue O, Brooklyn 30; DE 9-1857.

**RADIO RADAR TECH.**, 25; exp.; knowl. of television, radio telephone; 1/c lic.; coll. S. Goldston, 2915 W. 24th St., Brooklyn 24, N. Y.

**RADIO TECH.**—AM-FM radar tel.; 1/c; 2 yrs. coll.; EE. M. R. Ducker, 90-14 Pitkin Avenue, Ozone Park, L. I. MI 2-2010.

**RADIO TECH.**—Some experience; will take apprenticeship if it has good prospects. B. Blum, 2104 E. 22d St., Brooklyn 29.

**RADIO TECH.**; diversified civilian-army radio, radar experience; desires int. pos. H. Simon, 1795 Hyrant Avenue, Bronx 60.

**RADIO TECH.**; pre-war exp. bench, lab., army instructor, mechanic, car. P. Tuler, 2450 Lurling Ave., Bronx 87; OL 2-9218.

**RADIO** School Student wants full time pos. with radio firm in city. J. Cohen, 2027 78th St., Brooklyn 14, N. Y.

**RADIO TECH.**; 4 years experience; RCA grad; desires position in electronics; sal. secondary. B. Sobolnick, 87 Greenpoint Avenue, Brooklyn 22.

**RADIO TECH** trainee attending day school; desires evening work 6-10. A. Vilenky, 193 Orchard St., New York City 2.

**RADIO OPER.**—Navy exp.; R/T, W/T, FCC lic.; minor tech. work. H. Needles, 3619 Bedford Ave., Brooklyn 10; ES 7-4450.

**RADIO MECH.**, 24; married; 3 years army experience; desires more practical training. H. Donzky, 365 Sheffield Avenue, Brooklyn, N. Y.

**RADIO TECH.**—4 years experience, theoretical, practical schooling; 2/c radio telephone lic. E. Cohen, 513 E. 99th St., Brooklyn 12, BK 4-0213.

**RADIO OPERATOR AND TECHNICIAN** with 1st class radiotelephone license, ham license and three years experience operating in AAF, MOS 760 and 778, desires position. Box AT-1, c/o RADIO-CRAFT, 25 West Broadway, New York City 7.

**RADIO OPERATOR**; first class radiotelephone license; three years experience as transmitter operator with Army Airway transmitters employing up to five kilowatts output. Also graduate of two Army and one civilian Radio Schools. Prefer position as Broadcast transmitter operator. Barnard Stewart, P.O. Box 1676, New Orleans, La.

**ELECTRONICS TECH.**: Navy, Radio, Radar, Sonar, Loran; 3 years engineering, University of Michigan. R. Leopold, 68 W. 92nd Street, New York City 25.

**ELECTRONICS COPYWRITER**: Electronics schools; 5 years Jr. Engineer, tech writing; \$225 a month. Sargent, 35 Arden Street, New York 34.

**A START** at the Electronic Bottom—capable draftsman; civilian and Army experience; attending engineering college, evenings. (Completing third year.) Resume of qualifications on request. Bernard Meyer, 1320 Sheridan Avenue, New York 56, N. Y.

**ACCT.**; evening senior, coll.; acct., bookkeeping exp.; seeks permanent pos., CPA firm. D. Lerner, 2387 Creston Ave., Bronx 53.

**IMMEDIATELY AVAILABLE**: Radio-FM-Television instructor; 3 years experience; servicing receivers, transmitters and sound equipment; 10 years experience. Box AT-3, c/o RADIO-CRAFT, 25 West Broadway, New York City.

**RADIO REPAIRMAN**, neat, conscientious, seeks opportunity to work with experienced mechanic; 2 years civilian, 3 years army experience; salary secondary. Box AT-4, c/o RADIO-CRAFT, 25 West Broadway, New York City.

**RADIO & APPLIANCE** salesman, repairman, laboratory technician, own complete test equipment; 12 years exp. Abraham Lieberman, 2167 Pacific St., Brooklyn, N. Y.

**RADIO TECHNICIAN**, 5 yrs. exp. seeks pos. with progressive firm; 25 years old, single; have exp. with radio, radar, VHF; have worked as laboratory technician, inspector, radio serviceman; willing to start anywhere in plant located NYC, NJ area; willing to start at moderate salary. Harold L. Feilish, 2514 85th St., Brooklyn, N. Y.

**RADIO TECHNICIAN**, 1st class telephone license, practical repair exp., consider any opportunity in radio field. Jack Adler, 1889 50th Street, Brooklyn 4, N. Y.

**RADIO TECH.**, 24, 3 yrs. commercial exp.; 1st class phone license; will work anywhere in U. S. RADIO-CRAFT, 25 West Broadway, N. Y.

**RADIO TECH.**, 2/c, 22; 3 yrs. exp., interested in the job training or apprenticeship. Sam Steinman, 242 Floyd Street, Brooklyn, N. Y.

**ACCOUNTANT-PUBLIC**: Resuming civilian practice desires bookkeeping and auditing work for radio concerns. Have army radio experience. Harry M. Larris, One Parade Place, Brooklyn 26, N. Y. Phone BU 2-0462.

**RADIO TECH**, 23, 2nd class phone; 1 yr. Broadcast enr. coll.; limited exp.; limited worker. D. Gelb, 715 E. 4th Street, Dover, Ohio.

amateur antenna-transmission line is something very much desired but rarely obtained.

Parts for the set were all of pre-war vintage and were all on hand. With the quantities of war surplus stock now being offered to the public, acquiring the parts should not pose a serious problem. The following list is offered as a suggestion, but as there is little critical in the amplifier, substitutions may be made from more easily available surplus material.

### Parts List, TW-75 Amplifier

- 2—Neutralizing condensers, Hammarlund type N-10
- 1—Tuning condenser, Hammarlund type HFB-100-E
- 1—Tuning condenser, Hammarlund type HFBD, 100-E
- 1—Ceramic socket, 5-prongs, Hammarlund type S-5
- 2—R.f. Choke, midget, 2.5 mh, 125 ma
- 1—R.f. Choke, large, 2.1 mh, 500 ma
- 1—Set Barker and Williamson "TVL" variable-link transmitting coils
- 1—Base assembly for above
- 1—Set plug-in type transmitting coil, 75 watts, Barker and Williamson "Junior" JCL
- 1—Filament transformer, 7.5 volts a.c. center-tapped 10 amperes
- 2—Closed circuit jacks "long frame" type
- 1—Wire-wound adjustable resistor, 50 watts, Mallory 5AV7500
- 2—Mica transmitting condensers, .004, 1,000 volts
- 4—Mica transmitting condensers, .003, 1,000 volts
- 1—Mica transmitting condensers, .006, 1,000 volts
- 1—Mica transmitting condensers, .004, 5,000 volts
- 2—Ceramic sockets, chassis-mounting type, 4-prongs
- 1—Bakelite socket, chassis-mounting type, 5-prongs
- 1—Bakelite socket, chassis-mounting type, standard a.c.
- 1—Dial indicator handle and scale, large type
- 4—Porcelain feed-through insulators, 1" size type
- 3—Porcelain feed-through insulators, 1½" size type
- 1—"HRO" type dial, 0-10 degrees c.c.
- 2—High-voltage shaft couplers, National TX-9
- 1—Chromium-finished chassis, 17 x 12 x 4 inches
- 1—Black crackle steel panel, 12½ x 19 inches
- 2—Taylor TW-75 "thin-wall" carbon plate triode transmitting tubes.

## ALWAYS UNUSUAL VALUES AT LEEDS RADIO

### Check These BC-221 FREQ METERS



150—  
20,000 KC

Complete with tubes, crystal and calibration book.

Special \$54<sup>95</sup> at

### TBY TRANSCEIVERS

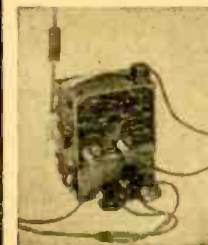

28 to 80  
Megacycles

Complete with tubes, crystal, phones, microphone.

A real \$29<sup>50</sup> buy at

### CONDENSER VALUES

- 1 Mfd 7500v D.C. Aerovox oil \$1.50
- 8 Mfd 2000v D.C. G.E. Pyranol 5.00
- 4 Mfd 600v D.C. G.E. Pyranol .95
- 10 Mfd 1500v D.C. G.E. Pyranol 3.50
- 2 Mfd 1000v D.C. G.E. Pyranol .95

### SIGNAL CORPS J-38 KEYS .89

### SELSYN INDICATORS



110 volt—60 cycle Selsyn motors can be ganged 1 to 5 or more as followers or indicators. \$18<sup>00</sup> Per Pair

A deposit of 25% must accompany all orders. All prices F.O.B. our warehouse New York.

## LEEDS RADIO CO.

75 Vesey St., Dept. 40  
CORtland 7-2612 New York City 7

### RADIO-ELECTRONIC QUIZ

How thoroughly have you mastered the contents of this magazine? Try the following quiz as a test:

1. Why do our radios not show the many "postwar" features expected? See page 745.
2. What is a "doodle-bug"? See page 746.
3. Who was the first man to transmit real television? See page 747.
4. Does a direction finder always indicate its bearing when the loop is receiving minimum signal? See page 751.
5. Can sound or supersonic waves be used like radar in detecting and ranging devices? See page 752.
6. How can parasites in a symmetrical r.f. amplifier be prevented? See page 755.
7. Why are such wide frequency bands needed for television transmission? See page 760.
8. Can FM transmissions reach the other side of the Atlantic? See page 765.
9. Is a combination of FM and AM in radio-telephone transmissions ever desirable? See page 784.
10. What is "vestigial side band" transmission? See page 801.

RADIO-CRAFT is in the market for good articles and photographs on industrial electronics, FM receiver construction and servicing, micro-wave apparatus and operation, new and interesting electronic devices, amateur radio technique, and receiver servicing. Best rates will be paid.

# HAM HEADQUARTERS FOR Equipment and Information

## EXTRA SPECIALS

- J-38 Key with Switch .80
- TAC MS700 Master Code Practice Oscillator 10.25
- Aero-Running time meter; 60 cycle A.C. 3.50
- Meters 2" case; 0-150 V-AC; 0-30V-DC-5 MA Movement 2.25 ea.
- DPDT Relay 5 V. DC 1.75
- 2 Mfd.—1000 V. Round can 1.50
- 3x3—600 V. oil filled .99
- Air Trimmers 100 MMfd .50

Mail Orders Promptly Filled  
Amateurs to Serve You  
(20% Must Accompany All C.O.D. Orders)  
Write Dept. RC  
W6SCQ—W6ITXN—W6NAT  
W6SSU

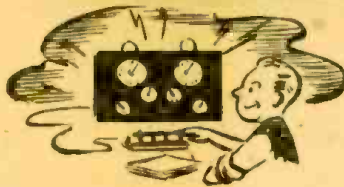

## FOR YOUR NEW RIG

We Have a Good Stock of  
All Standard Lines

**SUPER BOY!**  
ARMY BC-611F HANDIE-TALKIE, complete with Tubes and Batteries \$49.50

## Radio Product Sales Company

238 WEST 15TH STREET  
LOS ANGELES 15, CALIFORNIA Prospect 7471

### JUST OUT! Gov't Surplus

Solid Brass 12 Ft. Portable

## RADIO ANTENNAS

Real \$15 Value Now Only \$3.95 POST PAID

### FOR HOMES, BOATS or AUTOS

Same as used on Army tanks. These telescopic rustproof antenna have tremendous pick-up, eliminate dangerous wiring. Solid Brass throughout, practically insuring

### NOISE FREE RECEPTION

12 Exceptionally Rugged Sections  
Compress into 1 Ft. 4 in.

Handy for Camping Trips, also Useful for Transmitting, FM and Television sets.

Each antenna comes with clamps, nut, lug, and wire. Easy to install anywhere.  
**QUANTITY LIMITED.**

### MAIL ORDER TODAY

A real \$15 value for only \$3.95 Postpaid. Send check or money order now, or mailed C.O.D. plus postage. Money back in 10 days if not satisfied.

## RADIO HOSPITAL

1113 Lexington Ave. Dept. H  
New York 21, N. Y.

### Dealers WHY WAIT FOR YOUR RADIO?

## "BUILD YOUR OWN"

ATOMIC HEATER & RADIO CORP.  
PROUDLY PRESENTS

### The Finest in Radio Kits



A COMPLETE 6 TUBE SUPERHET.  
COVERS THE BROADCAST BAND FROM  
550-1700 KC

This set has been fully engineered and designed to make construction simple. All parts mounted, cabinet included.

Tubes required—two 12SK7, one 12SA7, one 12SQ7, one 35L6 and one 35Z5.

Your cost \$15.80 without tubes. Terms 10% deposit with order, balance C.O.D.

### IMMEDIATE DELIVERY

## ATOMIC HEATER & RADIO CORPORATION

Dept. R.C.  
104 PARK ROW, NEW YORK 7, N. Y.

## COMMUNICATIONS

(Continued from page 797)

Television, some years ago. I have been trying to contact him in regard to this article but have been unsuccessful. If he reads this may I hear from him.

WALTER J. BARTELL,  
1234 Marion Court,  
Chicago, Illinois

## VETERANS AND RADIO

Dear Editor:

It is gratifying to know that someone in the field of radio is interested enough in the welfare of the veteran to do something concrete about it. The situation in the field is not encouraging at the present and your concern gives me a needed lift.

Your offer to run my Situation Wanted ad arrived too late for me to take advantage of it for this coming issue of RADIO-CRAFT. I'm hoping that by deadline for your next issue, I'll be satisfactorily placed.

But if by chance I should still be without a job, I most certainly will avail myself of your kindness.

I'm sure there must be thousands of veterans like myself whose entire experience with radio has been in the Army but who feel sure enough of themselves to warrant trying to get into the industry. I've received some indication in certain firms that there is little sympathy with this desire.

It seems to me that the radio industry can well afford to gamble a little to give us an opportunity and at the same time develop that talent which Army experience gave a start.

Each manufacturer should undertake to take on a number of vets as apprentices in accordance with the total size of his labor force. I know the veterans would be more than willing to be a part of such a scheme in lieu of the apprenticeship program sponsored by the Veterans Administration.

I. WOLF  
New York, N. Y.

## LAY OUT ELECTRICAL DESIGNS and CIRCUITS FASTER



Only \$200 Postpaid  
**Saves Time**

For Professional, Student and Amateur IN RADIO - ELECTRICITY

RAPIDESIGN, INC., P. O. Box 592, Glendale, Calif.

**MAIL THIS COUPON TODAY**

RAPIDESIGN, INC., Dept. R-5  
P. O. Box 592, Glendale, Calif.

Gentlemen: Please send me postpaid ELECTRO SYMBOLS for which I enclose.....

Name .....  
Address .....  
City ..... State.....

## WORLD-WIDE STATION LIST (Continued from page 766)

Location	Station	Frequency and Schedule
Kwelyang	XPSA	7.010 11:30 pm to 1 am; 5 to 10 am
Shanghai	XGRS	11.690 10:15 to 11:30 am
Shanghai	XMHA	11.847 8 to 9 am
<b>COLOMBIA</b>		
Armenia	HJFH	4.880 6 am to 10 pm
Barranquilla	HJAB	4.785 5 to 10:55 pm
Bogota	HJCA	4.835 6 to 10 pm
Bogota	HJCC	4.955 10 am to 2 pm; 5 to 11 pm
Bogota	HJCX	6.018 7 to 8 am; 2 to 11:15 pm
Bogota	HJCD	6.160 7 to 8 am; 4 to 11:30 pm
Bogota	HJCT	6.198 evenings till 10:30 pm
Cartagena	HJAP	4.925 6 am to 1 pm; 5 to 10 pm
Cartagena	HJAE	4.965 4 to 10:30 pm
Medellin	HJDE	6.145 4 to 10:30 pm
<b>COSTA RICA</b>		
San Jose	TIPG	9.615 8 to 11:30 pm
<b>CUBA</b>		
Camaguey	COJK	8.665 8 pm to 12:30 am
Havana	COCO	6.130 9 am to 10 pm
Havana	COGW	6.330 7 am to 10 pm
Havana	COCO	8.696 7 am to 11:30 pm
Havana	COCQ	8.830 4:30 am to 12:30 am
Havana	COBZ	9.050 7 am to 11 pm
Havana	COCX	9.270 heard at midnight
Havana	COBL	9.833 7:15 am to 12:45 am
Havana	COX	11.615 11 am to 11 pm
Havana	CMCY	11.680 afternoons and evenings
Havana	COCY	11.740 afternoons
Havana		12:270 evenings
Havana	CMAS	15.505 6:45 to 7:30 pm
Santa Clara	COHI	6.456 7 am to 1 am
<b>OURACAO</b>		
Willemstad	PJCI	7.250 11:45 am to 12:15 pm; 3 to 4:30 pm
Willemstad	PJY9	9.340
<b>CZECHOSLOVAKIA</b>		
Prague	OLR2A	6.010 11 pm to 12:45 am
Prague	OLR3A	9.550 2 to 5 pm
<b>DOMINICAN REPUBLIC</b>		
Ciudad Trujillo	H11N	6.243 4 to 10:30 pm
Ciudad Trujillo	H12	6.310 4 to 9:30 pm
Santiago	H12A	7.080 10 am to 1:30 pm; 4:30 to 8:30 pm
Ciudad Trujillo	H12C	9.130 heard at 9 pm
Ciudad Trujillo	H13X	12.10 11 am to 1:30 pm; 5 to 9:30 pm
<b>ECUADOR</b>		
Cuenca	HC5EH	3.935 6 to 10:30 pm
Quito	HC1BF	7.160 6:45 to 11 am; noon to 2 pm; 5 to 11 pm
Quito	HCJB	9.958 afternoons and evenings
Quito	HCJB	12.445 afternoons and evenings
Quito	HDD	13.000 2:45 to 3:30 am
Quito	HCJB	15.110 mornings and afternoons
<b>EL SALVADOR</b>		
San Salvador	YSN	7.315 1 to 3 pm; 7 to 11 pm
San Salvador	YPSA	10.400 evenings

## WIDERANGE POCKET TESTER (Continued from page 790)

Precision resistors (a 500-ohm, 5 watt; and a 50,000-ohm unit will be found very useful) plus known voltages may be used for checking milliammeter scales. In such cases, low-resistance sources should be used. For example, a 50-volt B battery will probably not maintain its voltage if subjected to a 100-ma drain, where a storage battery will deliver many amperes without drop.

Resistance scales are checked with precision resistors of known value. Readings of the ohmmeter should compare favorably with the known resistor values. The resistors can be used in the future to check the ohmmeter batteries.

The capacity scales may also be checked with the two resistors. A reading of .66 milliampere should be obtained on the C x 1 range for 50,000 ohms, .13 for 50,000 ohms on C x 10 and .54 for 500 ohms on the C x 100 range. If these three readings are obtained, the scale which accompanies this article will be correct for your meter (based on 1 milliampere d.c. scale). Since a.c. is measured on the same shunts as d.c., separate calibration is unnecessary. This completes the calibration of the wide range pocket tester. Constant usage will soon make it the handiest piece of test equipment in your shop.

# PRE-EXAM TESTS

## For Commercial Radio Operator FCC LICENSE EXAMINATIONS



PREPARED BY ARTHUR R. NILSON, FAMOUS CO-AUTHOR of Nilson and Hornung's RADIO QUESTIONS AND ANSWERS.

**Don't Take A Chance!**

**Avoid Failure On FCC Commercial Radio Operator License Examinations!**

**USE NILSON'S COMPLETE PRE-EXAMINATION TESTS AND COACHING SERVICE**

Enables You To  
**REHEARSE** the FCC license examinations  
**PRACTICE** the procedure  
**PRACTICE** the multiple-choice examination methods used by FCC  
**CHECK** your knowledge  
**LOCATE** your weak points  
**CORRECT** your weak points before taking the actual examination  
 Use Coupon or write for Descriptive Folder  
 No obligation—no salesman

**Cleveland Institute of Radio Electronics**

Successors to Nilson Radio School, founded 1939  
 Smith Practical Radio Institute, founded 1934.

**RC-8 TERMINAL CLEVELAND 13, OHIO**

**MAIL THIS COUPON**

**CLEVELAND INSTITUTE OF RADIO ELECTRONICS**  
 RC-8 Terminal Tower, Cleveland 13, Ohio

Gentlemen: Please send information about Pre-Exam Tests.

Name .....

Address .....

City ..... Zone ..... State .....

# A LABORATORY QUALITY OSCILLOSCOPE For the Service Man . . .

Portable, sturdy, compact—the CRO-5A is an ideal unit for rapid, accurate, high quality service work. Check the utility and features which you have always wanted in the instrument on your bench.

- For better laboratory and production testing . . .
- For routine Service work . . .
- For studying any variable which may be translated into electrical potentials by means of associated apparatus . . .
- Designed with tubes for maximum amplification with minimum noise . . .
- Exceptionally stable trace even under adverse power line variations . . .
- Frequency response—essentially flat from 20 cycles to 350 KC . . .
- Completely self-contained . . .

Write to General Electric Company, Electronics Department SRC-6407, Syracuse 1, New York.



**CRO-5A**

**GENERAL ELECTRIC**

# GLAUB XTALS!

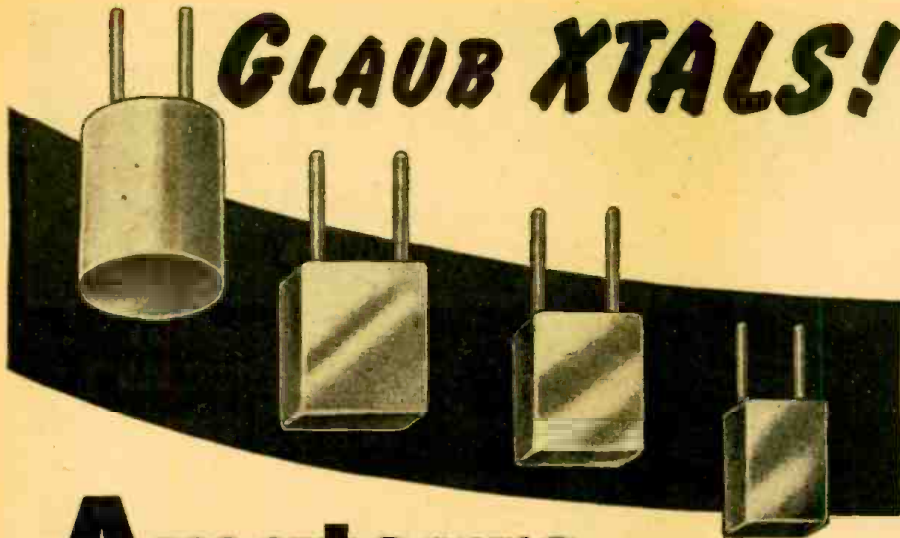

## Amateurs...

DO YOU know where you are in the Radio Spectrum? With a Glaub Xtal you can be sure. Our Xtals are ground to within .03% of specified frequency and guaranteed, with a temperature coefficient of less 3 cycles per megacycle per degree centigrade. They can't be beat! Attractive, convenient holders to fit any set. A custom built Xtal to your specifications at a standard price.

DELIVERED 48 HOURS AFTER RECEIPT OF ORDER  
LET US PUT YOU IN YOUR PLACE ON THE AIR!

### PIONEER ELECTRIC COMPANY

Western Distributors of Glaub Crystals

3700 East Olympic Boulevard • Los Angeles 23, California

### TUBE CHECKER MODERNIZER

(Continued from page 75A)

similar switch should be connected to each tube pin (Fig. 5).

The main bank of switches contains 32 single-pole toggle switches, arranged in four horizontal rows. From left to right, switches S1 through 8 are connected to the test socket contacts. Closing any switch in the plate line will connect the corresponding socket contact to the tube tester plate load (T1 in Fig. 3). Similarly, the screen line connects socket contacts to T2; the bias and a.c. signal line to T3; and the GND line provides a common ground connection T4. The ninth switch in the bottom row is normally closed across a 250,000-ohm resistor. For testing diodes this switch is opened, so that the proper diode load is obtained (Fig. 4).

If the obsolete tester is an emission tester, only the plate and ground rows of switches will be needed. Similarly, if all tubes are to be tested as triodes, the screen line can be omitted.

The upper rotary switch in the photo is a filament pin selector switch (SF1 in Figs. 4 and 5); the lower rotary switch (SF2) is the filament voltage selector, which enables application of filament voltages from 1.1 to 110.

#### SHORT TEST CIRCUIT

The short-test circuit (Figs. 4 and 6) is incorporated in a different panel. A.c. voltage from the tube tester power transformer (T5 in Fig. 3) is brought

into the control panel and through capacitor C (Fig. 6) to the movable contact of the upper switch section. The movable contact of the lower section is wired to an 80,000 ohm resistor and neon bulb. With switches S1 through S8 in the positions shown, all tube pins are connected to the upper switch section, and the upper contacts are wired to the lower section.

With the switch in position 4, as shown in Fig. 6, tube pins 1 through 4 are connected together by the shorting bar, and through capacitor C to the power transformer. Pin 5 is

# Electricity

Capacity range: 350 to 35,000 watts; 115 to 660 volts A.C.; 50 to 800 cycles; 6 to 800 volts D.C.; combination A.C.—D.C. types.

#### FOR RADIO AND ELECTRONIC APPLICATIONS

ONAN ELECTRIC GENERATING PLANTS supply reliable, economical electrical service for electronics and television applications as well as for scores of general uses. Driven by Onan-built, 4-cycle gasoline engines, these power units are of single-unit, compact design and sturdy construction. Suitable for mobile, stationary or emergency service.

Model shown is from W35 series; 2000 to 3500 watts; powered by Onan two-cylinder, water-cooled engine.

### D. W. ONAN AND SONS

2431 Royalston Avenue  
Minneapolis 5 Minn.



Write For Folder 690 describing complete Onan line

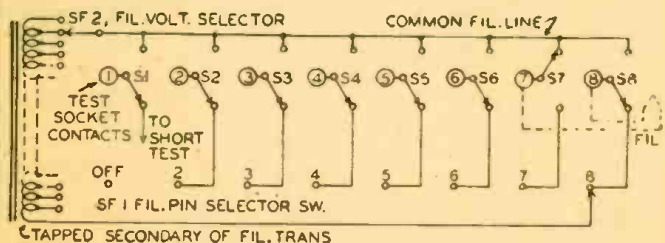
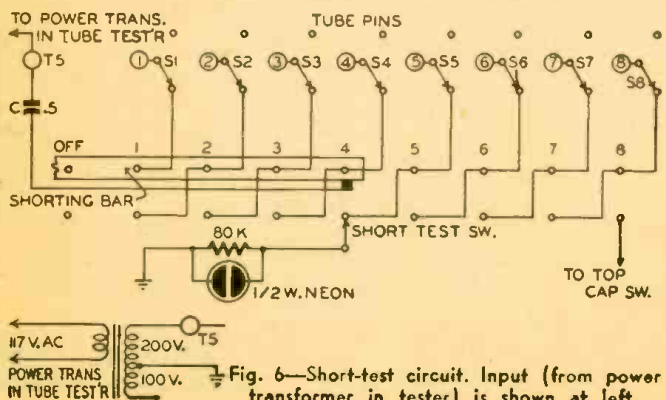

Fig. 5—Filament circuit for applying voltage to pins 7 and 8





connected through a jumper to the lower switch and to the 80,000 ohm resistor and neon bulb. If there is a short between pin 5 and the other 4 pins, the neon lamp will glow.

The short test will indicate filament continuity. For example, if a tube filament were between pin 5 and pin 1 in Fig. 6, the neon bulb would glow.

The capacitance of C must be low enough to provide a high reactance, so that the current will be limited to a safe value for all tube filaments. The capacitance C in Fig. 6 will limit the current to 50 milliamperes, when the transformer voltage is less than 250 volts.

The circuit also enables short tests with the tube filament heated. To do this, set the control panel switches to apply filament voltage (Fig. 5) and repeat the short test. Filaments that can be connected either in a series or in parallel must be connected in parallel, so that the lower filament voltage may be applied.

All line switches must be in their OFF positions while short tests are made. Conversely, the short test switch must be at OFF when a tube is checked for quality.

#### CONTROL PANEL OPERATION

Operation of the control panel is simple, for it is seldom necessary to use more than five switches to check quality. A few precautions must be observed. The filament selector switches should be adjusted first. This will prevent the application of plate voltage across the filament. Be sure to close the right switches; otherwise, you will make short circuits. *Know your circuits.*

It is not advisable to attempt a too precise calibration. There is nothing you can do about the design of the basic circuit. Most service checkers are comparison instruments; that is, tubes of the same type are tested under specified conditions, and the quality readings are compared with those of a good tube.

Calibration is required only for tubes that cannot be checked in the original checker. The tube checker chart can be used for any tube that is the equivalent, except for socket connections, of one that can be tested in the old tester. The article "Tube Replacements" in the October and November, 1945, issues of RADIO-CRAFT contains charts of tubes with exactly equivalent characteristics, and charts of tubes with small characteristic differences.

It is neither desirable nor necessary to try making up a complete calibration chart at one sitting. Make calibrations as the need arises and record the settings in your tube chart. The procedure is as follows:

1—Place a known good tube in the control panel. Refer to the receiving tube manual for correct socket connections, and set the control panel and test switches.

2—Carefully adjust the checker calibration controls to obtain a meter reading at the proper point in the GOOD area of the scale.

**THE SECRET'S OUT!**  
*The New and Spectacular*  
**ACA-100DC AMPLIFIER**  
*Is Ready For Delivery!*  
 DESIGNED BY A. C. SHANEY



**AMPLIFIER CORP. of AMERICA**  
 398 Broadway, New York 13, N. Y.  
**A. C. Shaney's FM-AM AMPLIFIER MANUAL is still available at 25c**

A revolutionary development in amplifiers cleverly designed to defy obsolescence and—amazing in its performance. New circuits, new materials and new processes are actually combined in this one amplifier to produce the most satisfying musical amplifier the world has ever known. If you are one of those discriminating persons for whom nothing less than the best is a disappointment, you are one for whom the ACA-100DC was designed. Send for technical literature.

3—Record the adjustments for future reference.

If power amplifiers, voltage amplifiers, and converters are tested for emission only (Fig. 1-a), they should be treated as rectifiers or diodes when tube checker calibrations are made. Power amplifiers should be discarded when their emission falls to the end of life value, for such a tube will invariably cause distortion when it is driven hard to obtain peak power output. Tubes that test in the ? area should be tested in their operating positions in a radio set. If set operation is satisfactory, these tubes are likely to provide good service for some time. Tubes that test in the BAD area should be discarded.

The following table will give an idea of the end-of-life point for various types of tubes, though in many cases the figure will vary from that given. Many converters will fail to oscillate while the reading is well within the given limits, and in many cases power output tubes will give satisfactory service when their output is lower than the average permissible minimum output. On a meter whose scale is divided in voltage, like the Triplett, the percentage can be calculated from the position of the pointer as compared with its normal GOOD position for the type of tube tested; on GOOD-BAD scales it may be roughly estimated, but will usually fall in the GOOD or ? portion of the scale.

Tube Type	End of Life Reading
Voltage Amplifiers	70% of normal GOOD reading
Power Amplifiers	70% of normal GOOD reading
Diodes	80% of normal GOOD reading
Rectifiers	80% of normal GOOD reading
Converters	60% to 70% of GOOD reading

Home Television will benefit from the wartime development of the television-guided-bomb when the principles of the "seeing eye" are applied to remote television pickup apparatus, it was announced last month by engineers of the Farnsworth Radio and Television Corp.

Visual pickups of news events—parades, sports, fires and other occur-

**DON'T CHANGE THE  
 CARTRIDGE—  
 CHANGE THE ARM  
 TO *Glider***



**THE SHURE *Glider*  
 MAKES IT POSSIBLE...**

- ✓ Records Last Longer
- ✓ Reduces Surface Noise
- ✓ High Output—Clear, Full Tones
- ✓ Needle Pressure—1½ oz.
- ✓ Easy to Install

MODEL 93A—\$6.10 LIST

Write for Catalog No. 156

**SHURE BROTHERS, Inc.**  
 Microphones—Acoustic Devices

225 West Huron St.  
 Chicago 10, Illinois

Cable Address:  
 SHUREMICRO



rences—are made possible by a portable camera-transmitter unit built originally to help bombardiers steer their missiles directly to the target.

# Introducing...

REPLACES OLD-STYLE  
OVER-THE-HEAD PHONES

A revolutionary departure in headset design, the Telex "Monoset" is worn under the chin instead of over the head. Eliminates ear pressure and head fatigue. Weighs only 1.3 ounces. Adjustable to all head sizes. Rugged tenite construction. High Fidelity Performance. Frequency response 50 to 3,000 cycles. Sound pressure output 300 - 400 dyns per sq. cent. Available in three impedances—128, 500 and 2,000 ohms.

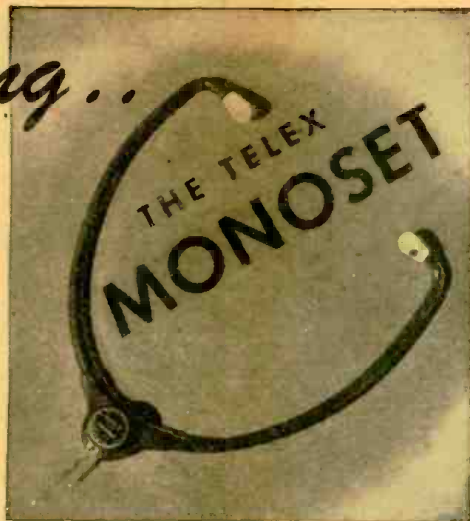

Territories Available  
Write for Particulars

**TELEX-INC.** ELECTRO-ACOUSTIC DIVISION  
MINNEAPOLIS 1 • MINNESOTA

## SPEED UP REPAIRS WITH THESE G-C AIDS!

### G-C is HEADQUARTERS for RADIO PARTS and SERVICE AIDS



All Types  
of Radio  
Cements,  
Chemicals,  
Coil Dopes,  
Compounds

G-C leads the field in supplying Radio-Electronic Manufacturers and Service Men with Parts, Tools, Radio Cements, Chemicals and Compounds. Insist on Genuine G-C Quality.

FREE  
STEEL  
CABINET

Dial Cables, Dial Belts,  
Packaged Hardware,  
Cabinet Repair Kits

SPEDEX  
Wire Strippers  
Alignment Tools  
Ne-O-Lite Testers

ORDER FROM YOUR JOBBER—SEND FOR G-C CATALOG



**GENERAL CEMENT MFG. CO.**  
ROCKFORD, ILLINOIS

### • Ted McElroy

World's Largest Manufacturer of  
Wireless Telegraphic Apparatus  
COMPLETE CENTRAL OFFICE EQUIPMENT  
**McElroy Manufacturing Corp.**  
92 Brookline Avenue • Boston, Massachusetts

Attention: Dealers, Servicemen, & Hams

Immediate delivery—if you act at once.  
Philco 6 1/2" recording discs, 8 for 48c. Studio 8"—  
25 for \$3.00; 1"—25 for \$4.50. Crescent & Garrard  
Changers—\$20.25 & \$72. Ray-Vac Farm Packs—  
\$4.77 and \$4.98. Bell 18 W. portable sound systems  
\$105. All types of phone kits \$10.80 and up. Melsner  
signal calibrators \$80.75. Raytheon RK-60 rectifier  
tubes \$2.75. Johnson ant. Insulators 7" 470—12" 59c  
All new stock. Send cash with order.

**Arrowhead Radio Supply Co.**

1216 "D" Street Phone 255-81 San Bernardino, Calif.



### TINY POCKET SIZE NEW RADIO!

Slips in your pocket or purse—  
Wt. only 3 ozs. Complete.  
READY TO PLAY an shown  
with self-contained blone for  
personal use. Smooth, durable  
black and silver plastic case. Was  
patented. Fixed Crystal—NO  
TUBES. BATTERIES OR ELEC-  
TRIC PLUG IS REQUIRED.  
USUALLY RECEIVES LOCAL  
BROADCASTS CLEARLY without  
outside aerial wire.  
GUARANTEED TO WORK when  
connected and used according to  
instructions sent with each radio.  
Can be used in homes, offices,  
hotels, cabins, bed, after hours, etc.

**SEND ONLY \$1.00** (cash, money order, check) and  
pay postman \$2.00, plus deliv-  
ery fees on arrival or send \$3.00 for postpaid delivery.  
IDEAL GIFT FOR CHILDREN OR ADULTS ALIKE!  
Get your PA-KETTE RADIO TODAY—NOW. Dealers in  
most cities.

**PA-KETTE RADIO COMPANY**  
DEPT. RC-8 KEARNEY, NEBRASKA

Buy U.S. Savings Bonds

## BETTER DIRECTION FINDER

(Continued from page 751)

swing back to the 45-degree position they formerly occupied on the right hand side of the scale. A fourth indication will be observed as the loop assembly is rotated to 315 degrees and

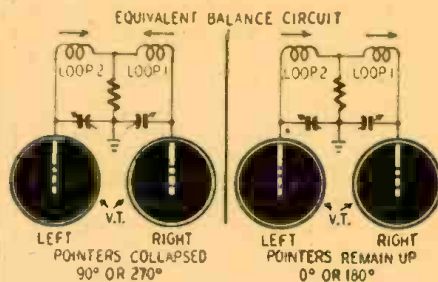

Fig. 5—Operation of the balancing circuit.

the crossed pointers swing back to the left hand side of the dial to a reading identical with the 135-degree indication.

Notice that we are now dealing with the incoming signals whose position with respect to the loops is such that unequal voltages are induced in the two loops; likewise, the pointer currents also will be unequal. There are four identical indications but two of them are on the right side and two on the left side of the indicator dial. Since there can be only one sensed azimuth this is established by rotating the loop assembly until the point of intersection of the crossed pointers reads 0 degrees on the dial and the sense and balance circuits employed to sense the incoming signal.

### BALANCE AND SENSE CIRCUITS

The Balance Circuit equalizes the effective amplification of each channel so that equal loop outputs will cause equal pointer deflections in the Direction Indicator. When the PRESS TO BALANCE switch is in the pressed position, as shown in Fig. 4, the low ends of each loop are disconnected from ground and connected together. This puts the two loops in series and applies the resultant loop voltage to the first

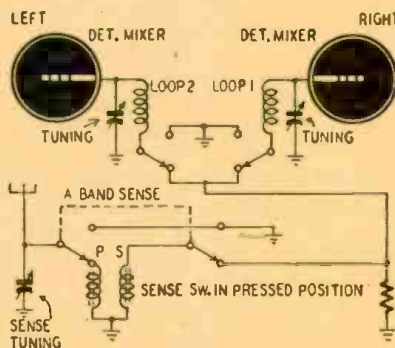

Fig. 6—The circuit for ahead-astern sensing.

tube in each channel. The resulting voltage depends on whether the individual loop voltages are in the same or in opposite directions. In Fig. 5-a  
(Continued on following page)

# HARD-TO-GET PARTS

## POWERFUL ALL-PURPOSE INDUCTION MOTOR

IDEAL FOR EXPERIMENTERS—101 USES



Sturdily constructed to precision standards, this self-starting shaded pole A.C. induction motor is powerful enough for a number of uses. Some of these are: Automatic Timing Devices, Current Indicators, Electric Fans, Electric Chimes, Window Displays, Photo-cell Control Devices, Electric Vibrators, Small Grinders, Buffers and Polishers, Miniature Pumps, Mechanical Modulators, Sirens, and other applications.

Consumes about 15 watts of power and has a speed of 3,000 r.p.m. When geared down, this sturdy unit will constantly operate an 18-inch turntable loaded with 200 lbs. dead weight—**THAT'S POWER!** Dimensions 3" high by 2" wide by 1 3/4" deep; has 4 convenient mounting studs; shaft is 7/8" long by 3/16" diameter, and runs in self-aligning oil-retaining bearings. Designed for 110-20 volts, 50-60 cycles, A.C. Only. Shp. Wt. 2 lbs.

ITEM NO. 147  
YOUR PRICE **\$2.95**

## ULTRA MAGNET

LIFTS MORE THAN 20 TIMES ITS OWN WEIGHT

LITTLE GIANT MAGNET



Lifts 5 lbs. easily. Weighs 4 oz. Made of ALNICO new high-magnetic steel. Combined with keeper. World's most powerful magnet ever made. The experimenter and hobbyist will find hundreds of excellent uses for this high quality permanent magnet. Measures 1 3/4" x 1 1/4" Shp. Wt. 3/4 lbs.

ITEM NO. 159  
YOUR PRICE **\$1.50**

## GENUINE MICROPHONE TRANSMITTERS

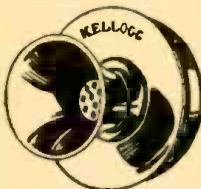

Regular telephone transmitters taken from a large telephone supply company's overstock. Work perfectly on 2 dry cells. Can be used on P.A. systems, call systems, inter-communications, e.t.c., short-line telephone circuits, house-to-house, or form-to-form phone lines, also to talk through your own radio or as concealed dictaphone pick-up. Useful replacements on battery-operated rural telephone lines.

THESE ARE GENUINE WESTERN ELECTRIC STROMBERG-CARLSON, excellent in appearance and operation. A remarkable value and one seldom offered in these times. Shp. Wt. 1 lb.

ITEM NO. 160  
YOUR PRICE **\$1.50**

## AMAZING BLACK LIGHT!!

Powerful 250-Watt Ultra-Violet Source

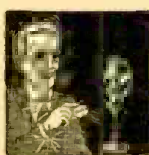

The best and most practical source of ultra-violet light for general experimental and entertainment use. Makes all fluorescent substances brilliantly luminous. No transformers of any kind needed. Fits any standard lamp socket. Brings out beautiful opalescent hues in various types of materials. Swell for amateur parties, plays, etc. to obtain unique lighting effects. Bulb only. Shp. Wt. 2 lbs.

ITEM NO. 87  
YOUR PRICE **\$1.95**

## WESTERN ELECTRIC BREAST MIKE

This is a fine light-weight aircraft carbon microphone. It weighs only 1 lb.

Mike comes with breastplate mounting and has 2-way swiveling adjustment so that it can be adjusted to any desired position. There are 2 woven straps; one goes around neck, the other around chest. Straps can be snapped on and off quickly by an ingenious arrangement.

This excellent mike can be adapted for home broadcasting or private communication systems. By dismantling breastplate, it can be used as desk mike.

Comes complete with 6-foot cord and hard rubber plug. Finished in unscratched plate, non-rustable. Shipping weight, 2 lbs.

ITEM NO. 152  
YOUR PRICE **\$1.49**



## WATTHOUR METER

Completely overhauled and ready for immediate service. Designed for regular 110-volt, 60 cycle 2-wire A.C. circuit. Simple to install: 2 wires from the line and 2 wires to the load. Sturdily constructed in heavy metal case. 8 1/2" high, 6 1/2" wide, 5" deep. Westinghouse, G. E. Co., Wayne, Sankamo or other available make. Shp. Wt. 14 lbs.

ITEM NO. 33  
YOUR PRICE **\$4.95**



HUDSON SPECIALTIES CO.  
40 West Broadway, Dept. RC-8-46, New York 7, N. Y.

I have circled below the numbers of the items I'm ordering. My full remittance of \$... (include shipping charges) is enclosed (NO C.O.D. ORDERS UNLESS ACCOMPANIED WITH A DEPOSIT.) OR my deposit of \$... is enclosed (20% required; ship order C.O.D. for balance; NO C.O.D. ORDER FOR LESS THAN \$5.00. BE SURE TO INCLUDE SHIPPING CHARGES.)

Circle Item No. wanted: 147 159 180 87 152 33

Name .....

Address ..... Please Print Clearly

City ..... State .....

the loop voltages are in opposite directions, which would be the case when the loop assembly has been turned 90 degrees to either side of the line of direction of the incoming signal. The loop voltages oppose each other, producing a resultant voltage of almost zero. This action, as the current flow to the pointers is now almost nil, causes abrupt collapse of the pointers on the Direction Indicator. If the loop voltages were in the same direction, as shown by the arrows in Fig. 5-b, the resulting voltages would be increased by the series connections and the needles would not collapse, indicating the direction of signal to be along the 0-180-degree line.

The Sense Circuit (Fig. 6) is employed to determine the sense of the

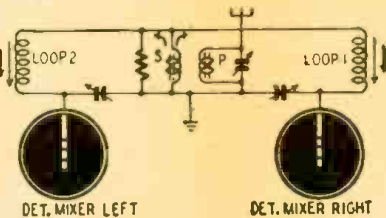

Fig. 7—Operational theory of sense circuit.

incoming signal; whether the signal is coming from AHEAD, 0 degrees, or ASTERN, 180 degrees. The antenna voltage from the secondary of the sense transformer, 488, is applied to both loop circuits (Fig. 7). The two loops are again connected in series, exactly as in the balancing circuit. Current from the sense antenna flows through both loops, producing a different effect in each as shown by the arrows in Fig. 7. The light arrows are for the currents due to the loops and the darker arrows are for the current due to the vertical antenna. This antenna current opposes the current of loop 1, producing a subtractive effect which reduces the reading of the pointer in its circuit. The antenna current adds to the loop current of loop 2, causing the pointer in that circuit to increase its reading. This results in a movement to the left of the crossed pointers and denotes that the sense of the incoming signal is AHEAD, according to the inscription above the Direction Indicator. Had the correct direction been the reciprocal, the crossed pointer movement would have been to the right showing that the transmitter was ASTERN.

Radio Homes in the United States increased 17.9 percent during the war years, the U. S. Census Bureau reported last month. Some of the increase since 1940 did not indicate a parallel rise in the number of radio receivers, it was pointed out, as in many cases parents gave up extra sets to young couples starting their own homes. Even allowing for these, the increase under war conditions was termed by Census officials "startling."

The total number of radio homes today, the report stated, is 33,998,000.

# NIAGARA RADIO SUPPLY



Timely offer:

JAN 829 B/3 E29 tube

add shielded aluminum

socket with built in

by-pass condensers.

Both for the price of

the tube socket

**\$6.95**



For you fellows who are planning a RM rig.

6200 Volts center

tapped at 700 mils

110 Volt 60 cycle

Amertran, type W frame

special

**\$39.95**

For that mobile rig - Pioneer gene-motor.

Delivers 500 Volts at 160 mils from a 6 or 12 Volt storage battery.

6 Volts at 21 amps input- complete with circuit breakers, in high voltage and low voltage circuits, Filter to kill hash, mounted on hard shock mounts. Here is your chance to run 75 watts or better - Mobile

**\$33.75**

Hewlett Packard Model 2008 Audio oscillator

20 to 20,000 cycles - a laboratory instrument

**\$74.95**

400 mils swinging choke built by Langevin.

A de Luxe job-swings from 9 to 60 henries.

50 to 400 mils - real regulation for only

**\$12.75**

8 1/2 amp Variac - General Radio, model 200C

the most popular item today

**\$10.95**

1 amp Variac General Radio 200B

**\$5.95**

LOOK - a real buy in a very useful Transformer.

650 Volts 125 mill C.T. secondary 10 volt 6 amp and 6 volt 5 amp 110 volts 60 cycle primary - going like hot cakes at \$2.98

# NIAGARA RADIO SUPPLY

160 GREENWICH ST.  
NEW YORK 6, N.Y.  
Send for Latest Bulletin



# BOOK REVIEWS

**RADIO'S SECOND CHANCE**, by Charles A. Siepmann. Published by Little, Brown & Company. Stiff cloth covers, 5 x 7½ inches, 282 pages. Price \$2.50.

There has been a tendency to refer to this book as a popular version of the FCC Report on Public Service Responsibility of Broadcast Stations. While this is not the case, it is difficult to review the book without referring to the earlier FCC report.

In his first chapter, *The Air Is Yours*, the author makes quite clear the fundamental reason for government and public "interference" in broadcasting. To operate their private business, the broadcasters must use public property, and property strictly limited in its availability.

Succeeding chapters compare the original theories and intention as to the nature of broadcasting, embodied in the Communications Act, statements of the Secretary of Commerce and officials of large broadcasting companies, with present-day performance and concepts; the part played by the networks; the meaning of "freedom of speech" on the air, both in theory and actual practise; and the influence of prospective large profits on programming. A chapter: *Washington's No. 1 Whipping Boy, the FCC*, again assails that much-abused organization, this time for timidity and failure fully to protect the listening public.

Few listeners—other than those whose interest in radio is commercial—will disagree with the author's thesis—that present broadcast programming falls far short of perfection. His suggestion that the coming of FM—with its opportunity to put large numbers of new stations on the air—amounts to a "second chance" for radio, will not be so widely accepted. Nowhere does the author show any factors which would in-

dicade that the development of FM will differ from that of AM, and his final chapter is more an expression of hope than a plan.

While the book can by no means be considered a substitute for the FCC report, both will be read by all who have a deep interest in the future of American radio.

**RADAR, WHAT IT IS AND HOW IT WORKS**, by Orrin E. Dunlap, Jr. Published by Harper and Brothers. Stiff covers, 5½ x 8¼ inches, 203 pages. Price \$2.50.

This book is written to give the non-technical reader an insight into the history, development and applications of radar.

In the opening chapter, Mr. Dunlap reveals that predictions of the possibilities of radar were made by scientists many years prior to World War I. He tells how through the years scientists have worked with radar principles in mind and, with the help of late scientific developments, were able to make it a reality. Chapter three carries interesting "case records" of radar at war. It describes how naval engagements were fought and won without seeing the foe with the human eye.

Chapter Four is devoted to answering questions most commonly asked by the public. It answers such questions as "What is a radar 'scope'?" and "How does radar calculate distance?" All of the questions in this chapter are answered in a clear and non-technical manner.

The concluding chapters show how the works of many scientists and inventors were combined to produce radar in its many forms. The peacetime possibilities of radar will come somewhat as a surprise to the reader.

A radar glossary and a list of suggested reading conclude the book fittingly.—R.F.S.



Suggested by: Roland Gutknecht, Merrill, Wisconsin

"I knew Junior would leave us alone after I gave him those Handie-Talkie sets."

## LIBERTY RADIO KITS

**6 Tube "Super Hot" Radio Kit**  
Complete Including Attractive Walnut Cabinet

Your Cost **\$16.95**

Diagram Furnished

Less Tubes, Wire and Solder.

**ALL PARTS MOUNTED**—Uses one 25L6, one 25Z6, one 6SQ7, one 6SK7, two 6SJ7's or one 50L6, one 35Z5, two 12SJ7's, one 12SQ7, one 12SK7.

**5 Tube "Super Hot" Radio Kit**  
Your Cost **\$13.95**

Diagram Furnished

Less Tubes, Wire and Solder Complete Including Attractive Brown Bakelite Cabinet

**ALL PARTS MOUNTED**—Uses one 25L6, one 25Z6, one 6SQ7, one 6SK7, one 6SA7 or one 12SA7, one 12SQ7, one 50L6, one 35Z5, one 12SK7.

10% DEPOSIT—BALANCE C.O.D.

**LIBERTY SALES CO., INC.**  
115 WEST BROADWAY NEW YORK 13, N. Y.  
DEPT. K

a Sensational **TERMINAL Value!**

### VIBRATOR INVERTER

For changing 115 Volts DC to 115 Volts AC, 60 cycles, 25 watts.  
SIZE 4½" high x 4" wide x 2½" deep.  
Shipping weight 1 lb.

**\$7.95**

Plus 25c for shipping & packing

Ideally suited for running AC Phonograph Motors off DC current, and any other electrical devices that require AC current up to 25 watts. Well constructed with built-in fuse for safety.

**TERMINAL Radio Corporation**  
85 CORTLANDT ST. N. Y. 7, N. Y.  
WOrth 2-4415

# SCHOOL DIRECTORY

PREPARE NOW FOR SKILLED JOBS IN RADIO AND ELECTRONICS  
 a place for yourself in a new world of radio and electronics—a world in which revolutionary electronic developments will require highly specialized technical knowledge. Take a good course now to fit yourself for a good paying job. The training you need can be supplied by one of the schools advertised in this publication.

**RADIO**

Train with professionals. Complete, intensified courses; Repair & Maintenance, Communications, High-speed telegraphy, Slip transcription, FCC exams, etc.

High School Students accepted for training as Merchant Marine Radio Officers. Gov't sponsorship available to veterans.

"A Radio School managed by radio men."  
 45 W. 45th St., Dept. RC, New York 19, N.Y.

**MELVILLE RADIO INSTITUTE**

**SENDING RECEIVING SPEED**

Be a "key" man. Learn how to send and receive messages in code by telegraph and radio. Commerce needs thousands of men for jobs. Good pay, adventure, interesting work. Learn at home quickly through famous Candler System. Write for FREE BOOK.

**CANDLER SYSTEM CO.**  
 Dept. 3-J, Box 928, Denver 1, Colo., U.S.A.

**RADIO**

RADIO Technician and Radio Communications courses. Register now for new classes starting first MONDAY of each month. Day and Evening Classes.

**AMERICAN RADIO INSTITUTE**  
 101 West 63rd St., New York 23, N.Y.  
 APPROVED UNDER GI BILL OF RIGHTS.

**LEARN RAPID RADIO SERVICING**

Send for Free Information: "3 Ways to Learn Radio." Approved for Training Veterans.

**WESTERN RADIO INSTITUTE**  
 1457 Glenarm, Denver 2, Colo.

## TRANSATLANTIC NEWS

(Continued from page 765)

the date, the time and the item heard and I shall be glad to verify.

**ONE FOR THE WORKSHOP**

Being myself one of those who delight in workshop jobs, I am always on the look-out for tools and gadgets that make easier the tasks of the dyed-in-the-wool radio constructor. Here is one, now appearing in the toolshops over here, which has proved itself a real gift of the

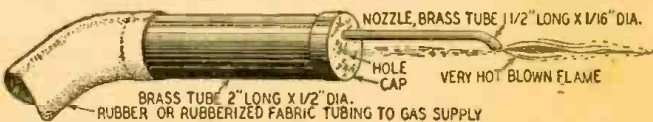

This self-acting blowtorch is as effective as it is easy to build.

gods in my workshop. As the figure shows, it is just one of those simple things that make you take running kicks at yourself for not having thought of long ago. It consists of a piece of brass tubing half an inch in diameter by two inches in length. One end is open. The other is closed by a screw-on cap, into which is fixed a piece of 1/16 inch di-

**Correspondence Courses in RADIO and ELECTRICAL ENGINEERING**

**ELECTRICAL ENGINEERING** Get good grasp of wide electrical field. Prepare yourself, at Low Cost, for secure future. Modern, simplified you can understand quickly.

**RADIO ENGINEERING** Extra fine course in radio, public address, photo-electric work.

Trains you to be super-service man, real vacuum tube technician. Servicemen needed badly. Diploma on completion. Tuition \$25, either course. Deferred payment plan.

**FREE** Get copies of school catalogs, student magazines, complete details. **SEND NOW!**

**LINCOLN ENGINEERING SCHOOL** Box 931C-90, Lincoln, Nebr.

**RCA INSTITUTES, Inc.**

Offer thorough training courses in all technical phases of **Radio and Television**

DAYS—EVENINGS WEEKLY RATES

**VETERANS:** RCA Institutes is approved under G. I. Bill of Rights For Free Catalog Write Dept. RC-48

**RCA INSTITUTES, Inc.**  
 A Radio Corporation of America Service  
 75 VARICK STREET NEW YORK 13, N. Y.

**RADIO ENGINEERING I**

**VETERANS** can complete work here in shortest possible time. Courses also in Civil, Electrical, Mechanical, Chemical, Aeronautical Engineering; Business Administration, Accounting, Secretarial Science. 63rd year. Enter Sept., Jan., Mar., June. School now filled to capacity. No applications can be accepted until further notice.

**TRI-STATE COLLEGE** 2456 College Ave. ANGOLO, INDIANA

**COMMERCIAL RADIO INSTITUTE**

A radio training center for twenty-five years.

**RESIDENT COURSES ONLY**

Broadcast, Service, Aeronautical, Television and Marine telegraphy classes now forming. Literature upon request. Veteran training. Classes now forming for Oct. 1st.

Dept. C, 38 West Biddle St., Baltimore 1, Md.

vantages over the more familiar kind: it requires no pumping up, but continues to function without attention as long as you need it, and it comes instantly into full action when lighted. How does it work? The nozzle, as you can see by stopping the small hole with a finger, simply produces an ordinary rather low temperature gas flame. But when the small hole is open gas issues from it at high velocity and drives air across the end of the nozzle, thus giving rise to a very hot blown flame. I find this little tool invaluable not only for a thousand and one constructional jobs, but also for the quick dismantling of out of date pieces of radio gear—one "whiff" and a joint comes apart instantly.

## BOOK REVIEWS

(Continued from page 807)

**SCIENCE YEAR BOOK OF 1946**, by J. D. Ratcliff. Published by Doubleday & Co. Stiff cloth covers, 5 1/2 x 8 1/2 inches, 245 pages. Price \$2.50.

This, the fifth annual issue of Science Year Book, is a compilation of scientific articles on chemistry, physics, medicine, agriculture, aviation and other subjects, that have appeared in leading non-technical magazines within the last year. The articles are grouped according to subject matter. Of particular interest to the radioman are the articles on radar, atomic power, the vacuum tube and Citizens Radio. All articles are on a non-technical plane and are devoted to the historical background of the subject and to predictions of future uses and applications.

**THE DECIBEL NOTATION AND ITS APPLICATION TO RADIO ENGINEERING AND ACOUSTICS**, by V. V. Lakshmana Rao. Published by Addison & Co., Ltd. (Madras, India). Stiff covers, 5 1/2 x 8 1/2 inches, 176 pages. Price \$3.00.

This book is one of the few on the subject that has been prepared in the English language. It is devoted entirely to acoustics and signal strength levels in radio equipment and audio systems.

It is divided into four parts. Part I begins with a definition of the decibel and its logarithmic development. General expressions and formulae are given for gain and loss at various power, voltage and current levels. Tables and charts are included for rapid conversion of power or voltage ratios to decibels.

The second part is devoted to a study of the *phon* and its use in acoustic engineering. Part III describes many applications of the decibel in radio and acoustic engineering. Particular attention is paid to amplifier hum and noise levels and to receiver selectivity and image ratios. The concluding section is a discussion of the various types of graphs and their applications and limitations in radio and acoustics. A bibliography of related reading and a short index are useful additions to this section of the book.

YOU CAN GIVE BETTER, FASTER SERVICE with these

# 3 BALANCED RESISTOR ASSORTMENTS

STURDY, HANDSOME Resist-O-Cabinet

**FREE** WITH EACH ASSORTMENT

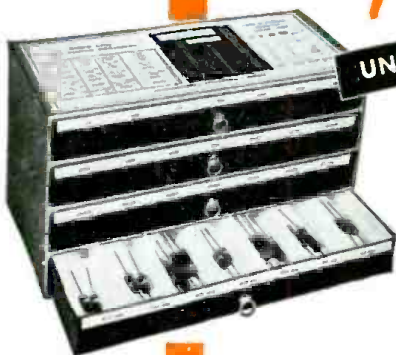

**UNIVERSAL ASSORTMENT**

Balanced resistor assortment. Includes 59 IRC Type BT Insulated Metallized Resistors and "universal" 10-Watt Power Wire Wound Types AB and ABA. The ABA (adjustable) type makes possible every range from a few ohms up to 10,000 ohms.



**1/2 WATT ASSORTMENT**

100 Type BW-1/2 and BTS Resistors. A complete assortment of most used ranges in the popular 1/2-Watt Insulated Metallized and Insulated Wire Wound Types.

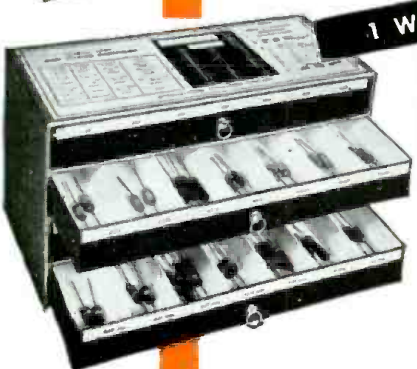

**1 WATT ASSORTMENT**

83 Type BW-1 and BTA Insulated Resistors. Every service engineer should have all of these top-quality 1-watt resistance ranges at his fingertips.

No one knows better than you that up-to-the-minute appearance and modern, efficient service pays off in your shop.

That's why IRC offers three Resistor Assortments to equip you for quick, easy resistor replacements on almost any job. Any one or all three IRC assortments, arranged according to type and range, are in neat, sturdy cardboard Resist-O-Cabinets that stack firmly one on top of the other. The cabinets are supplied absolutely *free* with each assortment ordered at standard resistor prices. Get in touch with your IRC distributor *today*

**EASY TO STACK** →

Bases of Resist-O-Cabinets are arranged for stacking so that several cabinets may be used to increase stock capacity.



**INTERNATIONAL RESISTANCE CO.**

401 N. BROAD ST., PHILADELPHIA 8, PA.

\*Canadian Licensee: International Resistance Co., Ltd., Toronto

Something's always going on

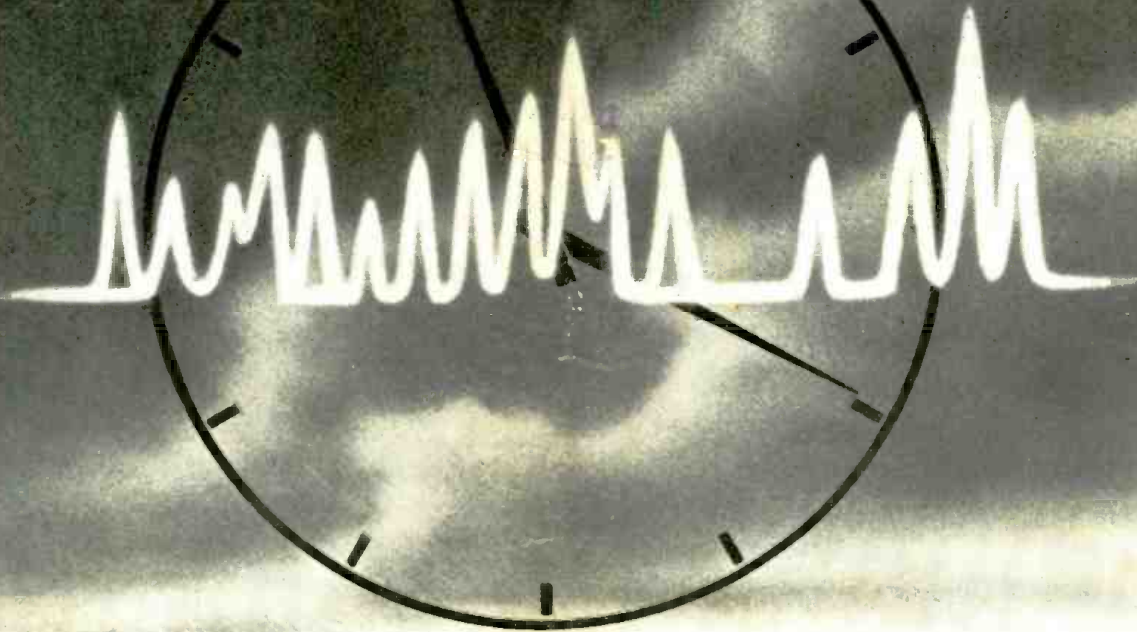

**..and you're missing most of it**

Amateur Radio Is Alert . . . Alive . . . Full of Action. Twenty-four hours a day the air is filled with signals . . . many of them of interest to you. But while you listen to one, you are virtually blindfolded, you can't know about the activity of the others . . . so you miss them . . . that is, without Panoramic Reception.

Only with Panoramic Reception can you see a continuous visible picture of band activity. Only with Panoramic Reception can you see stations come on the air, identify them and tune them in quickly, accurately, while looking at the other signals. Yes, only with Panoramic Reception can you see signals you might otherwise miss, signals you want to hear.



**Get what you're missing . . . with PANADAPTOR**

The PANADAPTOR is a 10 tube electronically tuned superheterodyne with a self-contained 'scope, complete for 115V, 50-60 cycle operation, at ONLY \$99.75 net.

GUARANTEED FOR ONE YEAR.

**PANORAMIC**

CABLE ADDRESS  
PANORAMIC, NEW YORK



**RADIO CORPORATION**

242-250 WEST 55<sup>TH</sup> ST. New York 19, N.Y.

Exclusive Canadian Representative: Canadian Marconi, Ltd.